

Wholesale of 1U standard chassis for metropolitan area networks

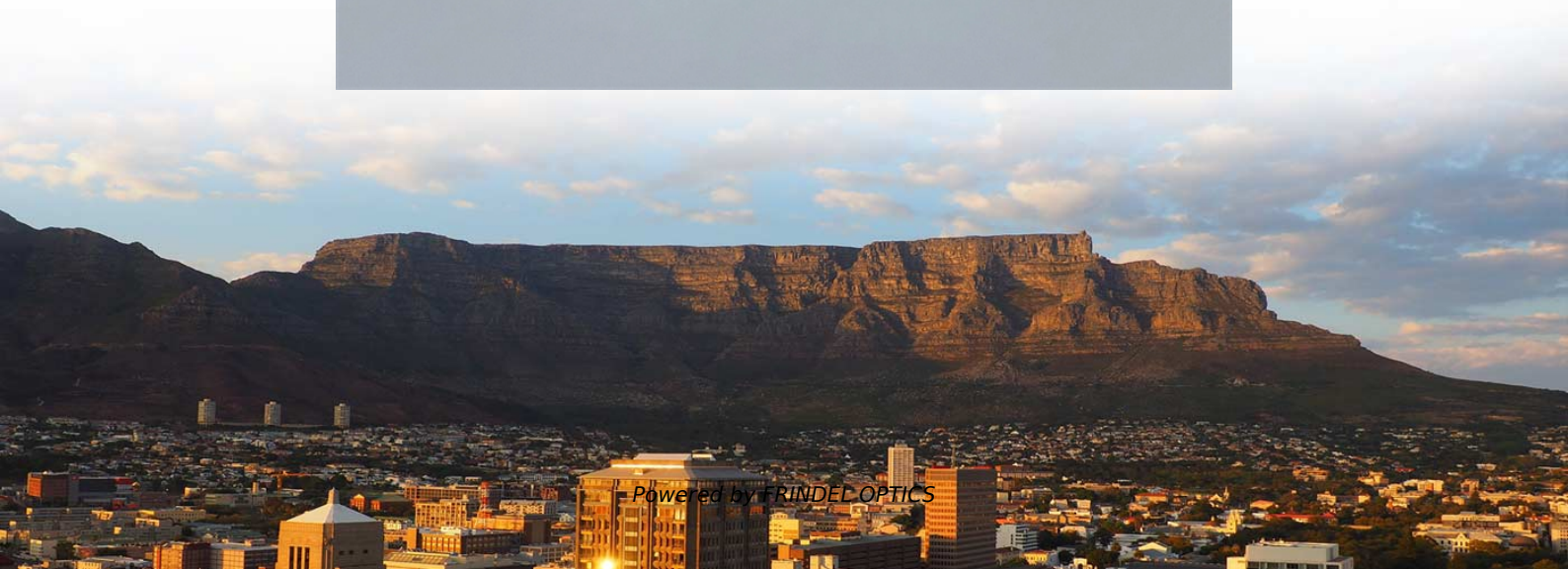



Wholesale of 1U standard chassis for metropolitan area networks



ETL Systems GNS-101-1U Genus 1U Modular RF

Model GNS-101-1U Genus 1U chassis has a modular design which can house any combination of compatible modules within the unit. Supplying operators with a

[Contact Us](#)

Legrand Q-Series Standard Density

The Q-Series fiber enclosure system is designed to support standard density applications in building networks. The all-steel chassis enables reliable protection

[Contact Us](#)



Rackmount Mart

Selection of rackmount chassis, 1U, 2U, 3U, 4U, 5U, 6U, 7U, 8U rackmount, rackmount monitor, rackmount lcd, kvm, keyboard drawer, kvm switch, disk array,

[Contact Us](#)

What Is 1U, 2U, 3U, 4U, 5U, 6U, and 7U?

The 1U, 2U, 3U, 4U, 5U, 6U and 7U are all different sized rackmount servers, and the "U" following the number is short for unit. The number indicates the size of the rackmount, 1U being the

[Contact Us](#)



Professional Server Chassis Manufacturer

Focus on providing server and industrial chassis and professional integrated solutions, such as 1U rack chassis, 2U rack chassis, 3U rack chassis, and 4U

[Contact Us](#)



NA800 1U Network Server Appliance

NA800 1U Network Server Appliance NA800 1U Short Depth 8x 2.5Gb LAN Server Appliances available as components only or as fully built and tested systems with

[Contact Us](#)



1U Chassis

It provides a flexible high density system for managing fibre terminations, cabling and patching in data centre and LAN applications, optimising rack utilisation and minimising floor space.

[Contact Us](#)



1U

Key Features/Applications: Virtualization, Cloud Computing, Enterprise Server, Data Center Optimized, Entry GPU server, Rack Workstation
CPU: Single Intel® Xeon® 6300/ E-2400
Processor Chassis:

[Contact Us](#)



Industrial Computer Chassis

At ICP America, our high quality computer chassis catalog includes: rackmount chassis, compact wall mount chassis, embedded chassis, video systems and

[Contact Us](#)

1U Plug-In CWDM Chassis-Wholesale-Company

The 1U chassis can provide 2/4 slots to support all types of CWDM cards. It is suitable for CWDM centralized deployment and is widely used in metropolitan

[Contact Us](#)

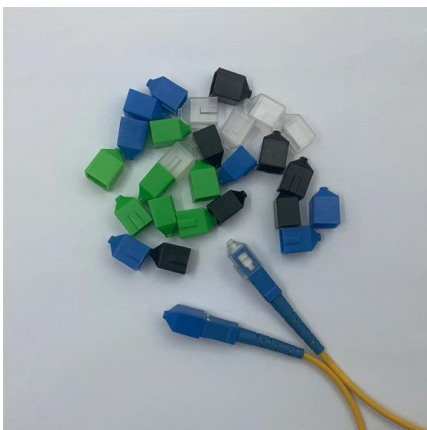

1U Rackmount Chassis

We offer a wide selection of 1U Height Rackmount Chassis supporting Passive Backplanes with Full Size SBC, or Mini-ITX Motherboard.

[Contact Us](#)



1u chassis , Newegg

1U server chassis / standard 19 "rack-mounted server chassis / 4 standard 3.5" hard disk slots / suitable for installation of various motherboards with E-ATX 12 "x 13" and below sizes / empty chassis

[Contact Us](#)

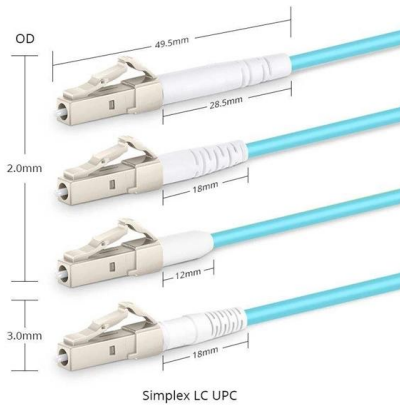

1U Chassis

The 1U chassis support multiple configurations include SATA hard drives, rackmount chassis and redundant power supply that fulfill server-grade IPC standard. The

[Contact Us](#)

D6000-CH1U, 4 Slots 1U Unloaded Chassis, Support Single

The D6000 series is suitable for IPoDWDM applications and flexible DWDM metro and edge network deployments. The platform is optimized for streamlined deployment and simplified operations,

[Contact Us](#)

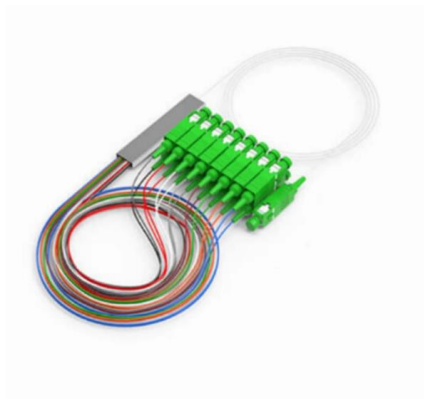
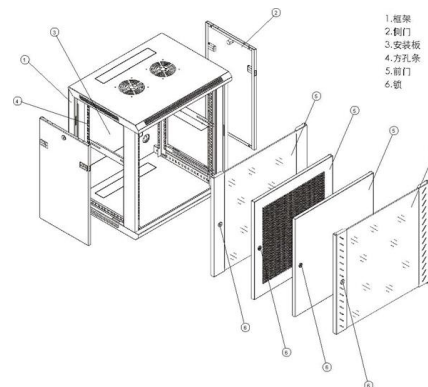

Network Equipment

Chassis 1U Network Equipment, height is standard 19 inch server case. Easy assembly and sturdy structure make it the best choice for many industrial

[Contact Us](#)

Server Chassis / Cases for Rackmount,



Broadest range of server case chassis available in all form factors. Modular with hot-swappable components, supporting the latest motherboards for Intel® and AMD

[Contact Us](#)

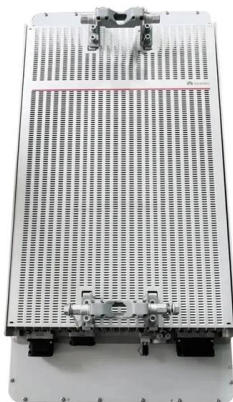
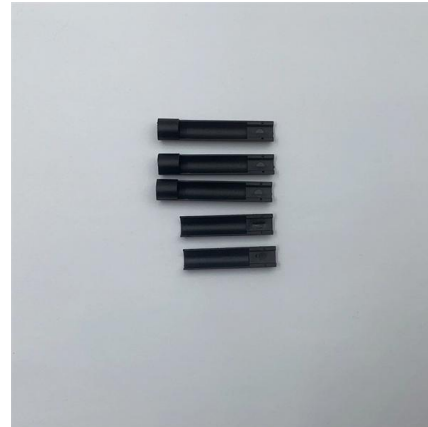

How to Set up a 100G Metropolitan Area Network?

Is your metropolitan area network (MAN) struggling to handle growing data traffic? With 100G technology, MANs are shifting from 10G/40G to 100G

[Contact Us](#)

FMT 1U Managed Chassis Unloaded

Description The FMT 1U managed chassis can hold both a NMU (Network Management Unit) main control module and 4x EDFA/OEO/OLP business modules, which allows you to optimize a solution

[Contact Us](#)

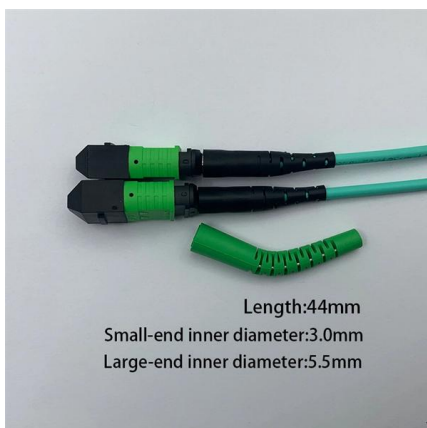

Length:44mm
Small-end inner diameter:3.0mm
Large-end inner diameter:5.5mm

Zettonics TEN21

The Zettonics TEN 1U chassis, mountable in 19-inch racks (other options available) provides user-friendly and flexible connectivity when combined with Zettonics TEN cassettes, harnesses, trunks

[Contact Us](#)



For this purpose, a modular 1U rack fit with various optical amplifier modules and multi-protocol transponder cards is available, which can be easily, quickly and

[Contact Us](#)

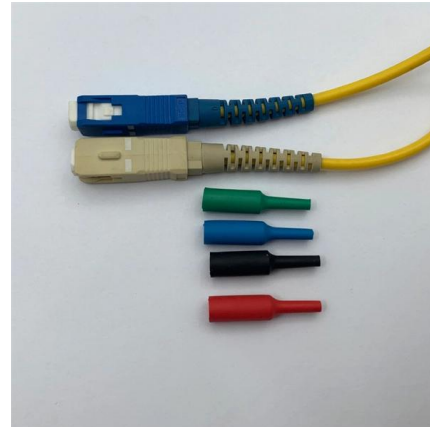

1U Chassis Images

1u (1 3/4") Heavy-Duty Rack-Mount Chassis Introducing the STRONGBOX® 1 3/4" high (1 rack unit) by 19" wide, heavy-duty rack-mount chassis. SBx-1 chassis are

[Contact Us](#)

1U Rack Chassis

A 1U rack chassis is a compact, standardized enclosure designed for mounting in server racks, widely used in data centers, enterprise networks, and cloud computing environments.

[Contact Us](#)

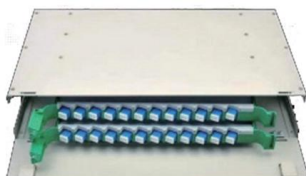

LANs, WANs, and Other Area Networks Explained

LAN and WAN are two common network domains, but many other types of area networks exist. Learn more about computer network types here.

[Contact Us](#)



Custom Chassis Solutions For A Variety Of IT

OneChassis specializes in providing custom chassis solutions for a wide range of IT equipment, including rackmount chassis and embedded computer cases. Our

[Contact Us](#)

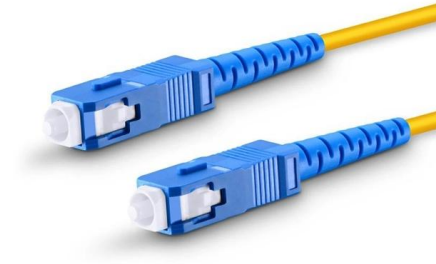

1U chassis

Find your 1u chassis easily amongst the 39 products from the leading brands (Kontron, ELMA, SUPERMICRO,) on DirectIndustry, the industry specialist for your professional purchases.

[Contact Us](#)

Contact Us

For datasheets, pricing, or custom fiber access solutions, please visit:
<https://frindel.es>