

Where is the switch on the fiber optic terminal box





Where is the switch on the fiber optic terminal box



Fiber Terminal Boxes: What They Are and Why You

A fiber terminal box, is a device used in fiber-optic communication networks to terminate, splice, and distribute optical fibers. It is a small enclosure

[Contact Us](#)

Fiber Optic Hardware , Fiber Panels, Housings, Racks, and

Fiber Optic Hardware Corning has a wide variety of hardware solutions to choose from to fit your cabling needs. Choose from racks, panels, modules, splice trays, ethernet fiber switches and other

[Contact Us](#)

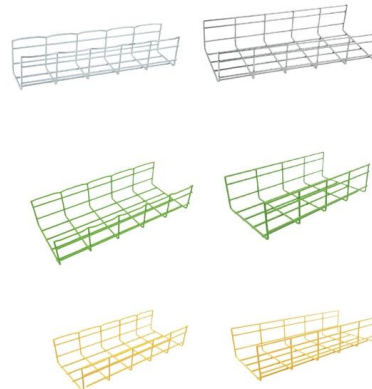

What is an Optical Fiber Terminal Box

Optical Fiber Terminal Box is a crucial component in today's FTTH networks, primarily used for terminating, connecting, and managing.

[Contact Us](#)

What You Need to Know About Fiber Terminal Box

The significant advantage of the fiber terminal box is that it can economically and efficiently achieve cable fixing, splicing and mechanical

[Contact Us](#)



Fiber Termination Box Installation & Maintenance Guide

It functions as a junction between the incoming fiber cable and the outgoing customer-side fiber cable, where one fiber can be spliced, patched, and

[Contact Us](#)

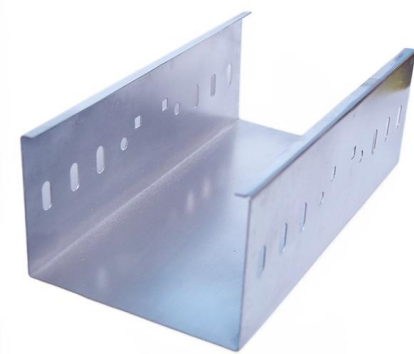

What is Fiber Termination Box

FTBs are typically installed on walls in user rooms or on racks in telecom rooms. They connect to various equipment, such as fiber optic cables,

[Contact Us](#)

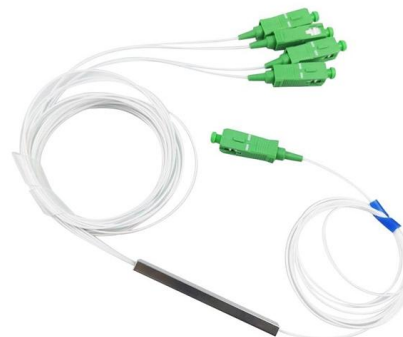

What is an Optical Network Terminal (ONT)? Your

This is where the ONT comes in ? What is an Optical Network Terminal (ONT)? An Optical Network Terminal (ONT), also known as a fiber

[Contact Us](#)



What Is the Role of a Fiber Optic Terminal Box in FTTH?

Discover the role of the Optical Fiber Terminal Box (FTB) in FTTH networks. Learn how rack-mount optical fiber terminal boxes in MDU risers and

[Contact Us](#)



Ultimate Guide to Fiber Optic Distribution Box: Types

Fiber optic technology has revolutionized the telecommunications industry, enabling faster and more reliable data transmission. One essential

[Contact Us](#)

Fiber to the x

Fiber to the x A schematic illustrating how FTTH (Node, Urban, Building, Home) architectures vary with regard to the distance between the optical fiber and the

[Contact Us](#)



What Is the Role of a Fiber Optic Terminal Box in FTTH?

When most teams plan an FTTH rollout, they obsess over feeder routes, splitter ratios, and ONT models--but the handoff point where glass meets

[Contact Us](#)



FTTH Terminal Box and Optical Accessories: A Comprehensive Guide

FTTH terminal boxes, also known as fiber to the home terminal boxes or FTTH distribution boxes, play a pivotal role in modern internet infrastructure. These boxes serve as the

[Contact Us](#)

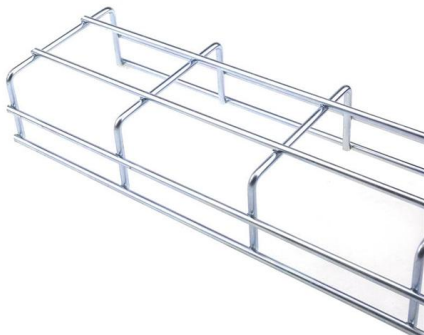

What is a Fiber Termination Box and How is It Used?

Fiber Termination Box is a device used for fiber optic network terminal access and management. It offers higher reliability and more flexible deployment

[Contact Us](#)

OPTICAL AA17053 Fiber Optic Terminal Box User Manual

Learn how to safely install your fiber optic cables with the AA17053 Fiber Optic Terminal Box. This user manual provides step-by-step instructions and usage information, including the required installation

[Contact Us](#)

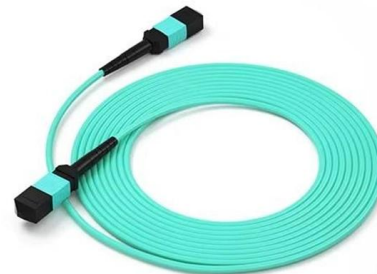

Fiber Terminal Box vs Junction Box: Key Differences

Compare fiber terminal box vs junction box in functions, applications, and installation. Learn which suits FTTH fiber vs electrical wiring.

[Contact Us](#)



Fiber Box Types and Applications in FTTH Network

The optical fiber faceplate panel is a user terminal box to realize the optical fiber to desktop connection with reasonable internal space design. It is used in home or work area to complete the

[Contact Us](#)



101 Guidelines for Fiber Termination Box

According to different designs, the FTBs can be divided into wall-mounted and rack-mounted boxes. The former is normally sealed hanging on the

[Contact Us](#)



All You Need To Know About Fiber Termination Boxes:

Source In this blog, we will discuss the two types of fiber optic cables and the role of a simple yet essential piece of equipment in the fiber laying

[Contact Us](#)



Upgrading To Fiber Optic Internet , Verizon Business

Upgrading to fiber optic internet? Experience faster speeds, greater reliability and enhanced business efficiency. Future-proof your connectivity today. Learn more!

[Contact Us](#)



The Intallation Guide Of Fiber Optic Terminal Box

The terminal box is the place where the end of the fiber optic is connected, and then connected to the optical switch through the optical jumper.

[Contact Us](#)

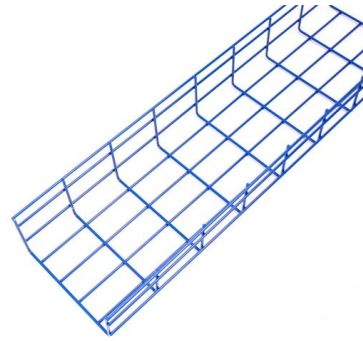

All You Need To Know About Fiber Termination Boxes: Installation

The optical fiber terminal box and the optical fiber splicing box are not interchangeable. The optical cable and the optical terminal are connected through the optical fiber terminal box, that

[Contact Us](#)

What is an Access Terminal Box? Key Functions, and

Cable Termination: The access terminal box allows for the safe and secure termination of fiber optic cables. In simple terms, it is where fiber optic cables are

[Contact Us](#)

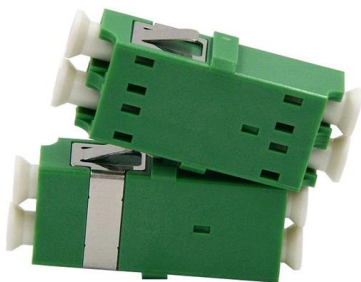
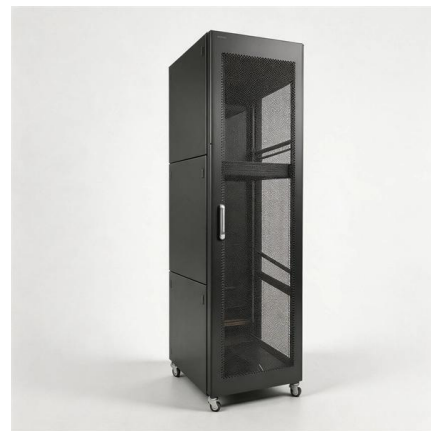

Adtran

Adtran is a leading global provider of open, disaggregated networking and communications solutions that enable voice, data, video and internet

[Contact Us](#)



Comprehensive Guide to FTB: Installation and Maintenance

Fiber Termination Boxes (FTBs) are crucial components in fiber optic networks, facilitating the termination, connection, and management of optical fibers. Proper installation and

[Contact Us](#)



Fiber Optic Internet Equipment Guide , Verizon Business

Get the fiber optic internet equipment guide to ensure a smooth setup and optimal performance. Find the right hardware for your business needs. Read now!

[Contact Us](#)

Ireland's Best Broadband Deals , Compare Broadband,

Best Broadband & TV Deals. Compare cheap broadband and TV packages, fastest broadband speeds, broadband coverage, & fibre and wireless broadband in Ireland.

[Contact Us](#)



Ordering information

MO	1	2	3	4	5	6
Model	SP2M1	SP2M2	SP2M3	SP2M4	SP2M5	SP2M6
Product name	Patch Panel	Patch Panel	Patch Panel	Patch Panel	Patch Panel	Patch Panel
Illustration						
MO	1	2	4	1	2	4
Maximum number of ports	144	288	576	144	288	576
Product size (including product and packaging)	482.8*202*144 mm	482.8*202*181 mm	482.8*202*177 mm	482.8*202*144 mm	482.8*202*181 mm	482.8*202*177 mm
Standard color code	RAL9005	RAL9005	RAL9005	RAL9005	RAL9005	RAL9005
Inventory	2	2	2	2	2	2

What is a fiber optic jumper? What is a tail line? What's

2. What is an optical fiber pigtail Optical cable pigtails, pigtails are also called pigtails. Only one end has a connector, and the other end is a broken

[Contact Us](#)



Contact Us

For datasheets, pricing, or custom fiber access solutions, please visit:
<https://frindel.es>