

What is the price of busbars

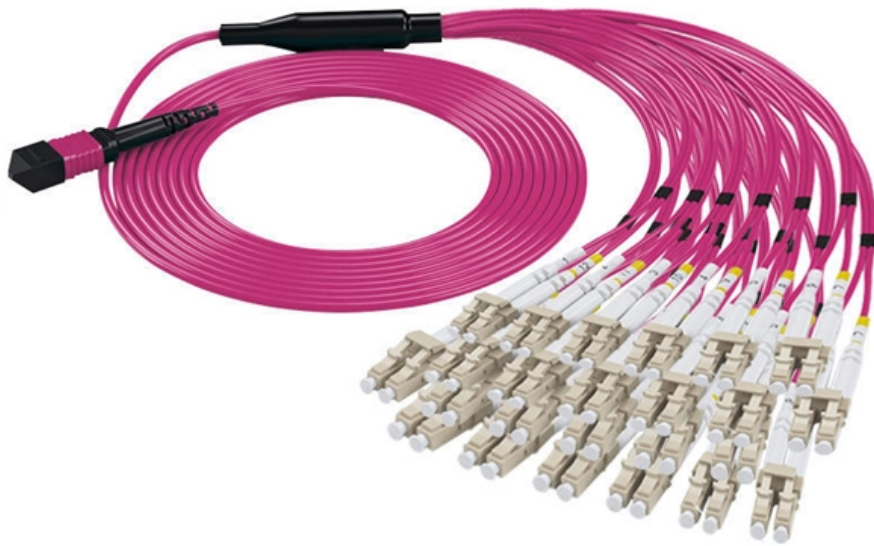



Overview

Busbar prices are shaped by far more than the daily cost of copper or aluminum. The real price depends on conductor material, cross-section, plating or insulation, cutting, punching, bending, short-circuit rating, and installation labor. This guide offers a detailed busbar pricing guide for electrical contractors, explores what affects pricing, and provides strategies to get the best value busbar products suppliers near you —without sacrificing quality. A Busbar is a clever bit of kit used to make complex power distribution easier, less expensive, and more flexible. Electrical busbars come in various forms such as solid bars, flat strips, or insulated combs. This information can help in making informed purchasing decisions, budgeting for projects, and evaluating the cost -.



What is the price of busbars

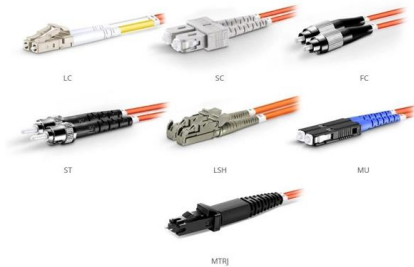

OM1 Fiber Patch Cable Family

Bus Bars , Ground Bus Bar Connectors, Electrical Bus Bars , RS

Bus Bars Where electric power distribution is needed, you'll find busbars. Whether you're searching for aluminum busbars, copper busbars or insulated busbars, you'll find them all and more at RS, in stock

[Contact Us](#)

Bus Bars , Ground Bus Bar Connectors, Electrical Bus Bars , RS

Busbars are also used in manufacturing settings, where flexible power distribution is essential thanks to the amount of machinery. Because the working stations and machine parts move, the electrical

[Contact Us](#)



Busbars - Mouser

View All Products at Mouser Electronics. Mouser Electronics is an authorized electronic component distributor offering online ordering and no minimum orders.

[Contact Us](#)



Busbar Price Guide: Key Factors, Materials & Machine

For this reason, two busbars with similar length may have completely different prices if their thickness, hole pattern, bending angle, material grade, or



What is the Market Price Range of MCB Busbar

Aluminum busbars typically have a lower price range, with some products available at relatively affordable prices. For example, some aluminum

[Contact Us](#)



Understanding Electrical Busbar Price - Factors,

Explore key factors affecting electrical busbar prices, market trends, and tips for smart purchasing to optimize cost and quality in power systems.

[Contact Us](#)



Bus Bars , McMaster-Carr

Choose from our selection of bus bars, including over 650 products in a wide range of styles and sizes. Same and Next Day Delivery.

[Contact Us](#)





The Benefits of Laser-Welded Busbars in Modern EV Battery Packs

The Silent Revolution: Why Laser-Welded Busbars Define EV Battery Safety The harsh reality of electric vehicle ownership is this: When your battery fails, you aren't just inconvenienced; you are stranded.

[Contact Us](#)

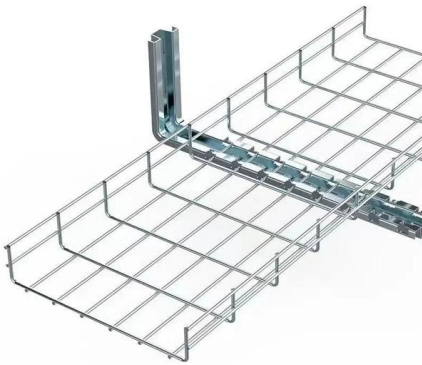

Busbars , Electrical Busbars & Copper Busbars , RS

Here, at RS we have a comprehensive range of Busbars supplied to you from industry-leading brands including Schneider Electric, Siemens, ABB, Eaton, and Legrand. As mentioned before busbars are

[Contact Us](#)

Electris

Bus bars are current conductors which ensure effective and efficient distribution of power. Bus bars are widely used in power engineering

[Contact Us](#)



Amazon : Bus Bar

RVMARINEPAT 12V Bus Bar 250A Power Distribution Block, 12 Volt Busbars 6 x 5/16" (M8) Terminal Studs Positive & Negative for Car, Marine, Solar Systems

[Contact Us](#)



Bus Bar Size Calculator

BUSBAR SIZE CALCULATOR Electrical power system consists of multiple incoming and outgoing feeder connection, for this electrical connection busbars are

[Contact Us](#)



Copper busbar UK specialists and stockholder

Copper busbar is used extensively in the electrical industry including control panels, switchgear components, panel boards and transformers. We are a leading UK

[Contact Us](#)

Understanding Electrical Busbar Price - Factors,

What Influences Electrical Busbar Price? The price of an electrical busbar is influenced by multiple factors, including material type (copper vs. aluminum),

[Contact Us](#)



Busbar Prices Explained: Copper vs Aluminum, Fabrication Costs

Learn what affects busbar prices, from copper and aluminum costs to fabrication, coating, fault duty, and total lifecycle value.

[Contact Us](#)



Price of Copper Bus Bars

Discover competitive price of copper bus bars, 99.9% pure, CE certified. Ideal for power distribution with custom fabrication and bulk options.

[Contact Us](#)

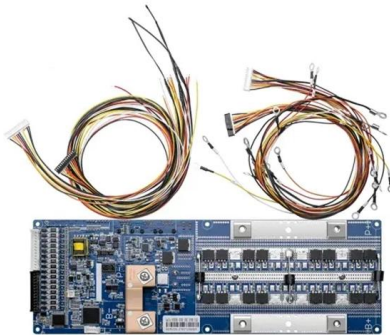
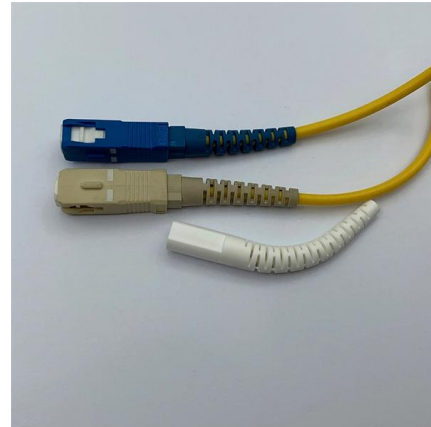

Busbar - Mouser

Show more Results: 78 Applied Filters: Type = Busbar Reset All Please modify your search so that it will return results. To use the less than or greater than function, please select a value first.

[Contact Us](#)

Electris

The busbars produced by Electris are known for their exceptional durability, precision, and flexibility. Manufactured from high-grade

[Contact Us](#)

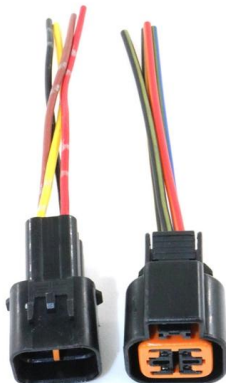

Amazon : Copper Bus Bar

Find reliable copper bus bars for electrical connectivity and power distribution. Choose from various sizes, materials, and configurations to suit your needs.

[Contact Us](#)

The \$27.71 Billion Power Revolution: Why



Busbars Are Becoming the

The market isn't without headwinds. Sharp increases in copper prices, particularly in 2024, are largely due to supply chain disruptions, increasing demand from renewable energy projects, and

[Contact Us](#)



Bus Bar Price

FTC BusBars: FTC BusBars is engaged in producing four pole busbar chambers. Their current rating ranges from 32 amperes to 600 amperes suitable for different requirements. They utilize a voltage of

[Contact Us](#)



Busbar Products Pricing Guide: Understanding Costs

Explore our Busbar Products Pricing Guide to budget smarter. Understand cost factors, compare price ranges, and find value-driven tips for copper busbar,

[Contact Us](#)

EFFICIENT FIELD TERMINATION

1. **PREPARE** - Strip and clean the fiber

2. **INSERT** - Fast and easy insertion

3. **LOCK** - Secure connection achieved

No Polishing | No Epoxy

Eliminates cable excess length and pigtail splice storage. Designed for high-efficiency onsite installation.

Amazon : Electrical Bus Bars

RVMARINEPAT 12V Bus Bar 250A Power Distribution Block, 12 Volt Busbars 6 x 5/16" (M8) Terminal Studs Positive & Negative for Car, Marine, Solar Systems

[Contact Us](#)



What is Electrical Bus-Bar?

An electrical bus bar is defined as a conductor or a group of conductor used for collecting electrical energy from the incoming feeders and distributes them to the

[Contact Us](#)

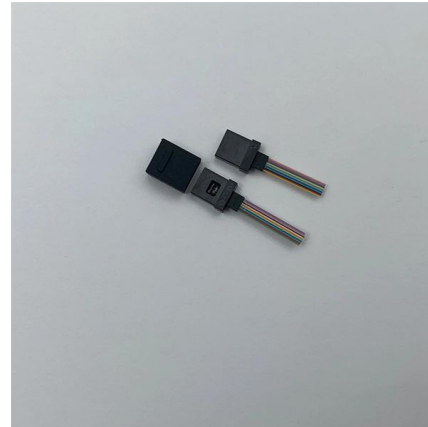

Busbars , Metelec

Metelec manufacture a range of Busbars including Aluminium, Flexible Connectors & Maxiflex

[Contact Us](#)

Busbars , Electrical Busbars & Copper Busbars , RS

Electrical busbars come in various forms such as solid bars, flat strips, or insulated combs. They are typically made from copper, brass, or aluminium. The primary function of a busbar is to carry

[Contact Us](#)

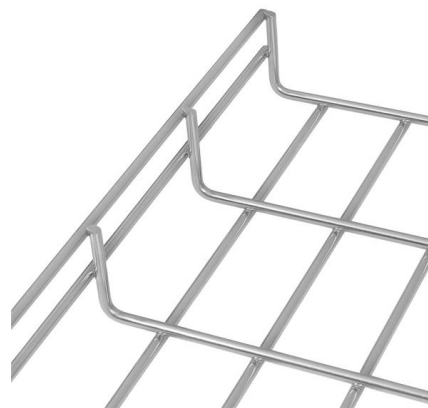

可选配件



Copper Busbar Market Size, Trends, Growth , 2035 Report

Key Market Driver: More than 74% demand growth is linked to renewable power infrastructure, while 63% of industrial facilities upgraded electrical systems and 58% of smart grid

[Contact Us](#)



Contact Us

For datasheets, pricing, or custom fiber access solutions, please visit:
<https://frindel.es>