

# What is an Optical Network Unit ONU





## What is an Optical Network Unit ONU

---



### What is ONU and Why Does It Matter for Your Internet

ONU stands for Optical Network Unit. In simple terms, it's a device that receives the optical signal from your Internet Service Provider (ISP) via a

[Contact Us](#)

### Optical Terminal

The OptiXstar product series extends optical connectivity to every home, enterprise, and campus, bringing families closer and making enterprise operations far more

[Contact Us](#)



### Optical line termination

Optical line termination An Alcatel-Lucent OLT used by the French operator CityPlay OLT and ONU in fiber optic network An optical line termination (OLT), also called an optical line terminal, is a device

[Contact Us](#)

### Fiber to the x

The optical network terminal (ONT, an ITU-T term) or unit (ONU, an identical IEEE term) converts the optical signal into an electrical signal using thin film filter

[Contact Us](#)

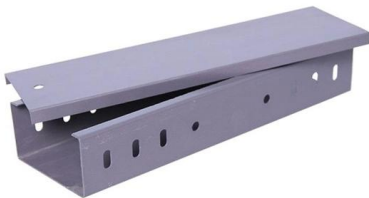

Explore the function and importance of the Optical Network Unit (ONU) in fiber optic networks. Learn how GIGAC ONUs provide reliable internet, voice, and video

[Contact Us](#)

### **ONU Optical Network Unit Explained-News-Gigac Technology**

An Optical Network Unit (ONU) is the key device in fiber optic networks, converting signals for end-users. This article explains its function, benefits, and features, including high-performance option

[Contact Us](#)

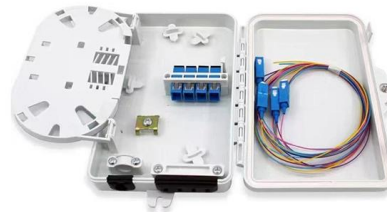

### **40G-OCDMA-PON network architecture with optical line**

Download scientific diagram , 40G-OCDMA-PON network architecture with optical line terminal (OLT), optical network unit (ONU), and remote node (RN). from

[Contact Us](#)



## Ubiquiti WAVE-FIBER-ONU GPON Fiber ONT 2.5GbE 1,200 Mbps

Bring fiber service to the edge with a GPON optical network unit designed for direct, high-speed handoff. The Ubiquiti WAVE-FIBER-ONU provides a single 2.5GbE Ethernet connection and supports up to

[Contact Us](#)

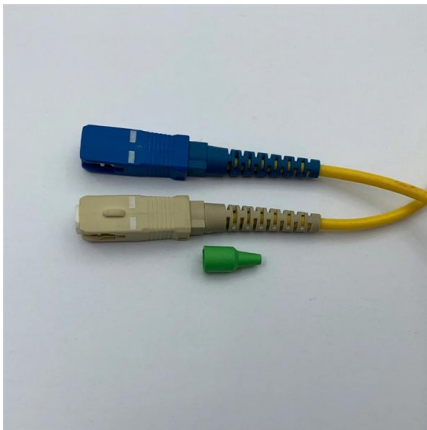

## Optical Network Unit (ONU): Definition, Working Principles, and Future

It was developed in the late 1990s and early 2000s, converting optical signals from the ISP into electrical signals usable by routers, computers, IP phones, or Wi-Fi access points. Think of it

[Contact Us](#)

**#opticalnetworkunit #onu #fiberoptics  
#ftth #gpon #**

Understanding the main components of a typical Optical Network Unit (ONU) is essential for optimizing fiber network performance, troubleshooting connectivity issues, and ensuring reliable last

[Contact Us](#)

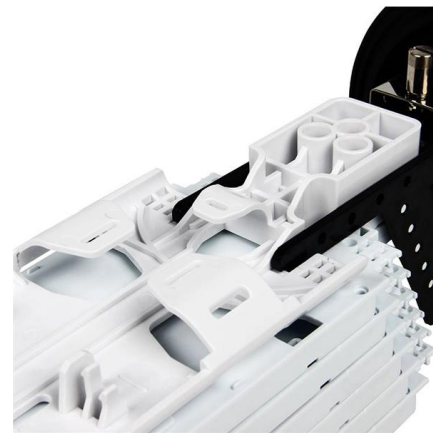

## Optical Network Unit ONU-Complete Guide

ONUs sit between the Optical Line Terminal (OLT) at the central office and the customer premises. They manage bandwidth allocation, ensure quality of service (QoS), and handle protocols for data, voice,

[Contact Us](#)





## Cheap Optical Network Units

Shop our range of optical network units for reliable fiber optic connectivity. Find high-quality ONU routers with features like GPON, Epon, and WiFi.

[Contact Us](#)



## How is Fiber Internet Installed? Everything You Need to

Explore how fiber optic internet is installed in your home, with step-by-step details on cables, ONTs, routers, and what to expect during the appointment.

[Contact Us](#)

## What Is an Optical Network Unit (ONU)? Easy Guide for Beginners

Confused about ONUs in fiber networks? This beginner-friendly guide explains what an Optical Network Unit is, how it works, why it's important, and the difference between ONU and ONT.

[Contact Us](#)



## ONU (Optical network unit)

In summary, an Optical Network Unit (ONU) is a vital component of fiber-optic communication networks. It serves as the interface between the optical

[Contact Us](#)



**#fiberoptic #ftth #gpon #telecom  
#networking #olt #ont #onu**

Fiber Optic is one of the most advanced communication technologies used today to deliver ultra-fast and stable Internet connections. Unlike traditional copper cables that transmit electrical

[Contact Us](#)



### **Optical Network Unit (ONU)**

An Optical Network Unit (ONU) is a device used in Fiber to the Home (FTTH) networks to connect end-users to the Passive Optical Network (PON). It is a key component of the PON architecture and is

[Contact Us](#)

### **What is fiber to the home (FTTH)?**

Optical network units (ONUs) closer to the end user's premises. An optical distribution network between the OLT and ONU to split and distribute the signal traveling along the PON.

[Contact Us](#)



### **Optical Network Unit , GPON ONU**

Sumavision provides first-class GPON Optical Network Unit (ONU) to help individual users connect to ultra-fast internet that delivered by fiber access network. It has

[Contact Us](#)



## TP Link XZ000 G3 OPTICAL NETWORK TERMINAL UNIT

Documents - tp link - xz000 g3 optical network terminal unit,xz000-g3-optical-network-terminal-unit Quick Start GuideGuideTP Link XZ000 G3 optical network terminal unit ONT ONU il y a 2 jours --

[Contact Us](#)

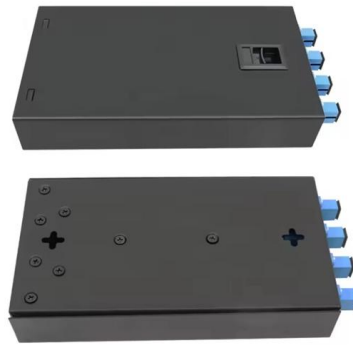

### 2.5 Gigabit (2.5GbE) GPON ONT (Optical Network Terminal)

An Optical Network Terminal (ONT), sometimes referred to as an Optical Network Unit (ONU), is a device that is placed at the customer's premises and securely connects the incoming fibre supply to

[Contact Us](#)



### What is an Optical Network Unit: Understanding

Explore the essential roles and functions of Optical Network Unit (ONU) in fiber optic networks. Learn how ONU works and transmits data.

[Contact Us](#)

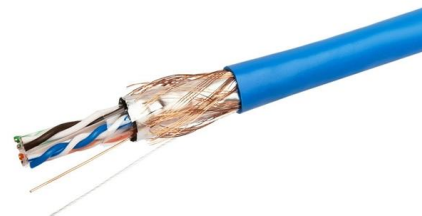

### Optical Network Unit (ONU) price in Bangladesh 2026 , RYANS

Buy original Optical Network Unit (ONU) at best price in Bangladesh. Get brand warranty, free delivery, COD and EMI offers on eligible orders.

[Contact Us](#)





## Xpon Onu Router at INR 1300/piece , Optical Network Unit in Guwahati

Xpon Onu Router - Buy Optical Network Unit at best price of INR 1300/piece by Redwan Telecom Private Limited. Also find product list from verified suppliers with contact number , ID: 2859204300348

[Contact Us](#)



## What is an optical network terminal (ONT)?

What is an optical network terminal (ONT)? An optical network terminal (ONT) is a device that serves as the endpoint of an optical network,

[Contact Us](#)

## Optical network terminal unit (ONT) design resources , TI

View the TI Optical network terminal unit (ONT) block diagram, product recommendations, reference designs and start designing.

[Contact Us](#)



## GPON ONU SFP Modules: High-Speed Fiber Connectivity Solutions

In the rapidly evolving landscape of fiber-optic communications, GPON ONU SFP modules represent a critical technological convergence. These compact, hot-pluggable transceivers are engineered to

[Contact Us](#)



### What is an Optical Network Unit (ONU)?

An Optical Network Unit (ONU) is a device used in fiber-optic communication networks, specifically in Passive Optical Network (PON) systems.

[Contact Us](#)

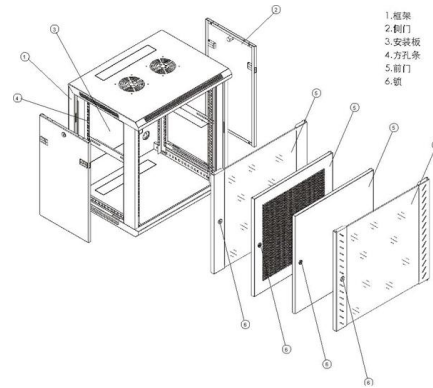

### What is ONU (Optical Network Unit)?

An ONU (Optical Network Unit) is a key device in Fiber-to-the-Home (FTTH) and other FTTx networks, operating within a Passive Optical Network

[Contact Us](#)

## Contact Us

---

For datasheets, pricing, or custom fiber access solutions, please visit:  
<https://frindel.es>