

Price of cable trays for Russian data centers

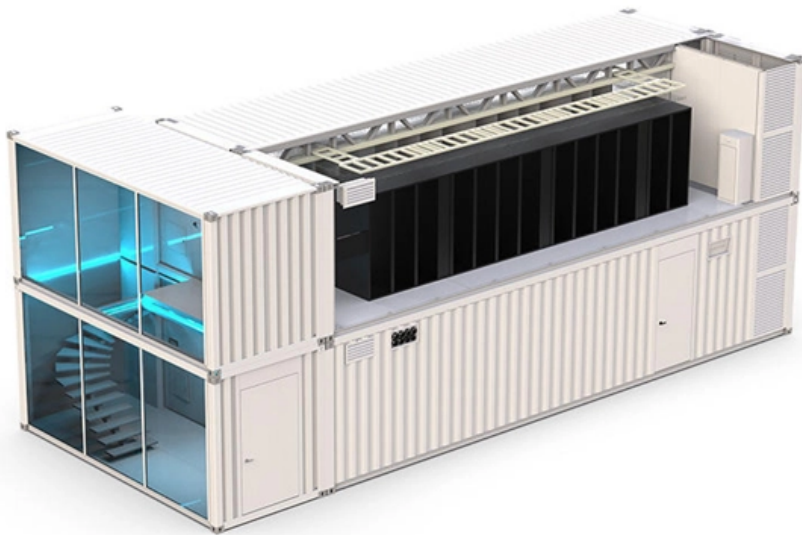

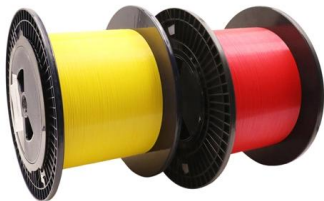

Price of cable trays for Russian data centers



Cable Trays for Data Centers Market latest Statistics

The Cable Trays for Data Centers Price Trend also reflects growing demand for pre-assembled tray modules. Prefabricated kits typically carry 8-14% price premiums but reduce installation costs by

[Contact Us](#)



Cable Tray Manufacturers in Russia, Hose Clamps, Crimping Tools

Started back in 1983, Cable House is a recognized name engaged in manufacturing and supplying wide range including Hose Clamps, Cable Ties, Crimping Tools, Cable Tray, Industrial Connectors and

Russia Cable Tray Market Overview, 2031

IT and telecom highlight innovation-driven adoption, serving data centers, telecommunications hubs, and office complexes requiring cable trays for structured cabling, space

[Contact Us](#)

Pre-Terminated Patch Panel

- Multi-application support
- Flexible configuration
- Modular design



Multi-functional Sliding Patch Box, Module



Modular Sliding Patch Box



Sliding Patch Box, Module

Wire Mesh Cable Trays in Data Centers: Why They're

For data centers, wire mesh cable trays offer the perfect balance of performance, flexibility, and cost-efficiency. Their open design enhances cooling,

[Contact Us](#)

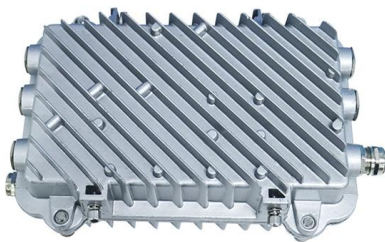

Maximizing Space and Efficiency in Data Centers with

Wire mesh trays offer multiple advantages for data centers. Their unobstructed structure improves airflow, helping cool high-powered electronics for

[Contact Us](#)

Cable tray systems support cables' journey through the

In many cases, a data center contains a significant number of cables to accommodate the network's high-volume, high-density connections. That being



[Contact Us](#)



Cable Tray Price List 2025: Current Market Rates

The global cable tray market is experiencing robust growth, driven by increasing infrastructure development, the expansion of data centers, and the adoption of smart technologies.

[Contact Us](#)



Russian Federation: Cable Trays and Ducts Market Report

This report analyzes the Russian plastic cable trays and ducts market and its size, structure, production, prices, and trade. Visit to learn more.

[Contact Us](#)

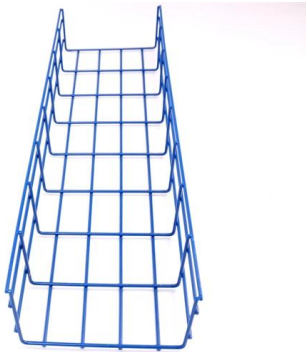

Cable Tray Suppliers for Data Centers & IT Infrastructure , West Port

Get high-performance cable trays, mesh trays, and accessories engineered for structured cabling and ventilation in data centers and IT facilities. Request a quote!

[Contact Us](#)

How to Choose Cable Tray for Data Centers?

Cable trays are essential elements that support and organize cables while ensuring optimal airflow and accessibility. Choosing the right cable tray can drastically improve the

[Contact Us](#)



Cable Trays for Data Centers: Perforated, Ladder or Wire Mesh

Choosing the right cable tray is key for data centers. Explore ladder, perforated, and wire mesh options for safe and effective cable management.

[Contact Us](#)



Cable Tray in Russia, Cable Tray Manufacturers Suppliers Russia

We offer Cable Tray in Russia in different specifications at competitive market prices. Our range is customized and passes stringent quality tests, before reaching the market.

[Contact Us](#)



Cable tray systems support cables' journey through the data center

In many cases, a data center contains a significant number of cables to accommodate the network's high-volume, high-density connections. That being the case, we asked providers of cable tray

[Contact Us](#)

Cable Runway & Tray Systems for Data Centers

Cable Runway and Tray Solutions for Data Centers At APES Engineering, we provide professional Cable Runway and Cable Tray solutions designed for modern data centers, server rooms, and IT

[Contact Us](#)



Cable Tray Market Share, Size & Growth Outlook to 2030

The Cable Tray Market is expected to reach USD 5.02 billion in 2025 and grow at a CAGR of 10.54% to reach USD 8.28 billion by 2030. Atkore

[Contact Us](#)

Reuters , Breaking International News &



Find latest news from every corner of the globe at Reuters , your online source for breaking international news coverage.

[Contact Us](#)

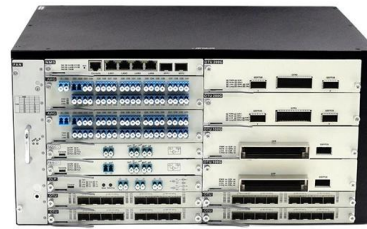

Cable trays

Made up of thick steel wire. Provides maximum ventilation and instant access to the cables. The price of the cable trays depends not only on the material (concrete, plastic, reinforced concrete, metal),

[Contact Us](#)

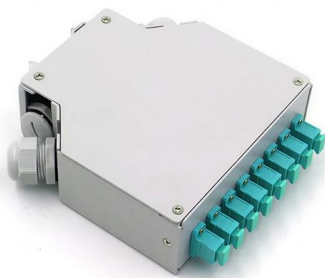

Cable Tray Strategies for AI-Ready Data Centers

As AI computing clusters scale to tens of thousands of GPUs, data center cable tray systems are evolving from static pathways to dynamic neural

[Contact Us](#)



Snake Tray's Smart Solutions for Data Centers

Snake Tray cable management and enclosures are being used in some of the leading data centers in the world. Our cable tray systems are built with features that make installations quicker and more

[Contact Us](#)

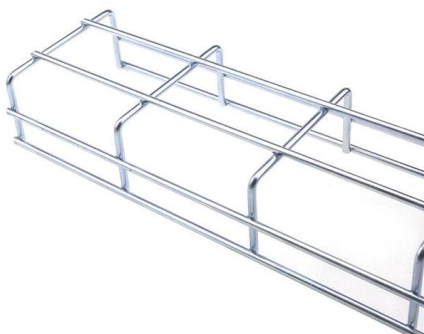

Data Centre Cable Trays: High-Density



Cabling Guide

Learn about Data Centre Cable Trays for high-density cabling. Get a guide on design, materials, smart management, & future tech for data halls.

[Contact Us](#)



ALBIMAX METALL

LLC «ALBIMAX METALL» - is a Russian supplier of electro-technical equipment (busbars, low-voltage switchgear, transformers), cable carrying systems (trays), lighting equipment.

[Contact Us](#)

About Us

Among those who have selected our company are institutional, commercial, residential facilities in such spheres as petroleum, chemical, defense industries all over the Russian Federation. Throughout the

[Contact Us](#)



Cable Tray in Russia, Cable Tray Manufacturers Suppliers Russia

We offer Cable Tray in Russia in different specifications at competitive market prices. Our range is customized and passes stringent quality tests, before reaching the market. As one of the best Cable

[Contact Us](#)

SS Cable Trays Applications in Power



Distributions

Stainless steel cable trays ensure efficient cable management & durability in power distribution & data centers across various industries.

[Contact Us](#)



Cable Tray Market Analysis, Size, and Forecast 2025-2029:

By closely monitoring inventory levels and demand, this company can ensure they have the right amount of cable trays on hand when needed, reducing the need for excess inventory and associated storage

[Contact Us](#)

Cable Tray Price List

Find reliable cable tray price lists from trusted suppliers. Shop high-quality, customized, and affordable options for your electrical needs. Bulk orders welcome.

[Contact Us](#)



Cable Tray Market Size, Share, Industry Report 2035

Major trends in the forecast period include growing deployment of modular cable management systems, rising demand for corrosion-resistant cable trays,

[Contact Us](#)



Contact Us

For datasheets, pricing, or custom fiber access solutions, please visit:
<https://frindel.es>