

# **Price of Fiber Optic KVM Project in Mali**

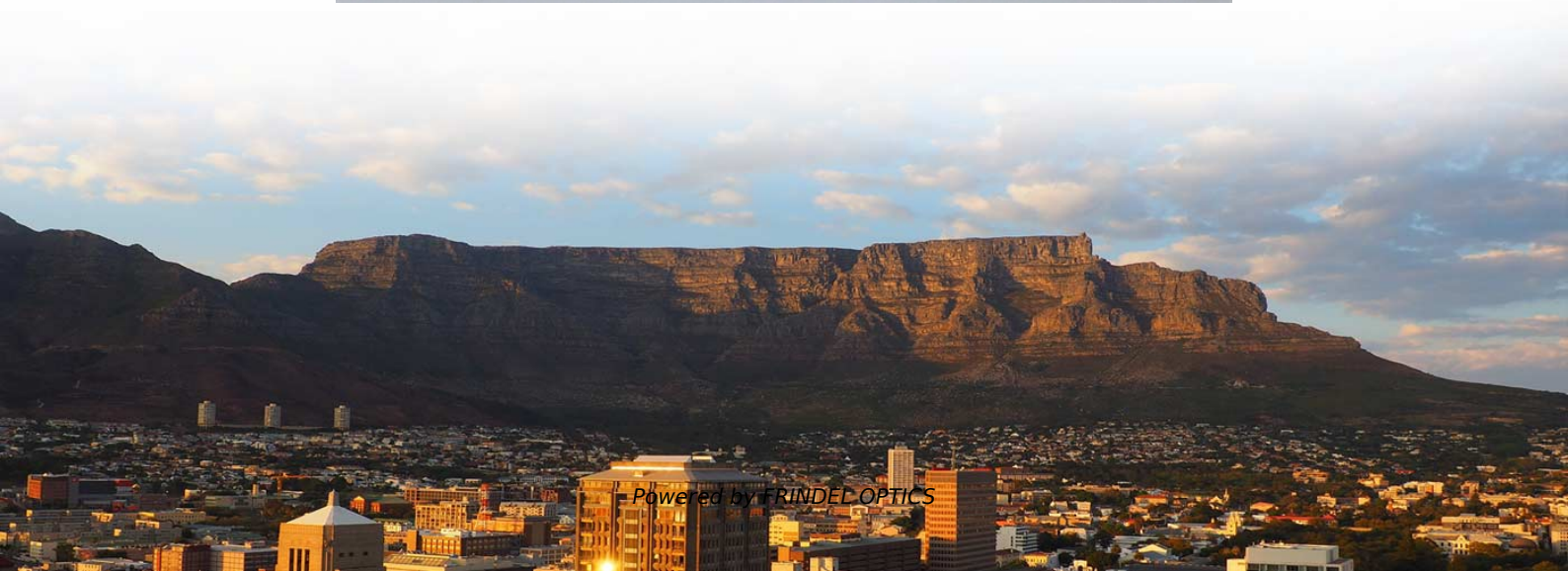



## Overview

---

3 million USD, the project was approved by the Council of Ministers on Wednesday January 3. The extension covers the areas of Mopti, Koro, Timbuktu, Gao, Ansongo and Labenzaga. The aim is to gradually include the 65% of the population who, according to DataReportal data, still lack access to the Internet. 3 million to the China International Telecommunication Construction Corporation (CITCC) to extend the country's national fibre optic network.



## Price of Fiber Optic KVM Project in Mali

---



### **Mali: Govt To Invests US\$117 Billion To Strengthen**

This project is expected to improve the quality and reduce the cost of internet services in the targeted areas and extend the reach of these services to

[Contact Us](#)

### **Mali awards CITCC US\$117m contract to expand fibre network**

Under the contract, CITCC will expand Mali's fibre network to areas including Mopti, Koro, Tombouctou, Gao, Ansongo, and Labenzaga. The project is expected to take two years to complete,

[Contact Us](#)



### **IFC and Orange Mali Partner to Expand Rural**

An EUR80 million loan (equal to about XOF 52.5 billion) from IFC and other investors will enable Orange Mali to install 300 new 4G towers and expand

[Contact Us](#)

### **Mali awards CITCC US\$117m contract to expand fibre network**

The project is expected to take two years to complete, the report said. The Malian government said the fibre project will not only extend broadband connectivity to the unconnected, but



**Mali: USD 117.3 million for the extension of the national fiber optic**

Mali: USD 117.3 million for the extension of the national fiber optic network The Malian government has entrusted the extension of the national fiber optic network to the Chinese company



[Contact Us](#)

**Mali : 117 millions de dollars pour étendre le réseau de**

Le gouvernement de transition du Mali a décidé d'initier un nouveau projet dans le secteur des infrastructures. Au cours de sa session du 3 janvier

[Contact Us](#)

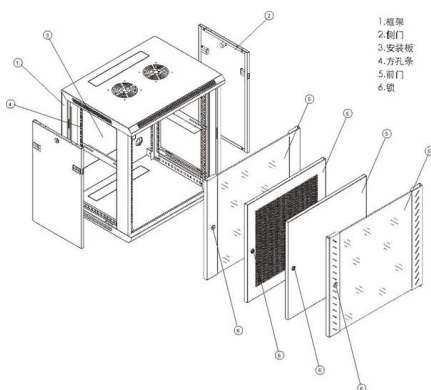

**CE680**

The Aten CE680 is a DVI Optical KVM Extender that overcomes length restrictions of standard DVI cables by using fiber optics to send high definition audio, video and

[Contact Us](#)

**Mali: USD 117.3 million for the extension of the national fiber optic**



With a total cost of 117.3 million USD, the project was approved by the Council of Ministers on Wednesday January 3. The extension covers the areas of Mopti, Koro, Timbuktu, Gao, Ansongo

[Contact Us](#)

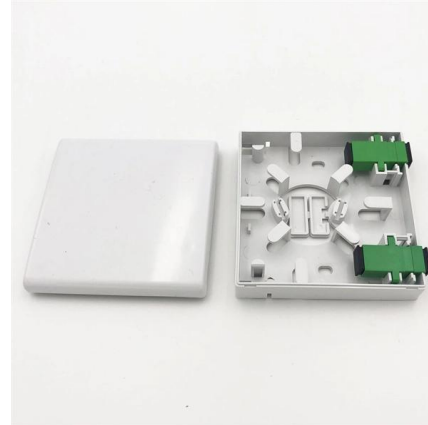

### Mali government invests \$117.3 billion to improve fiber optic network

The Malian government seeks to strengthen the national telecom infrastructure as part of its digital transformation ambitions. The aim is to gradually include about 65% of the population who

[Contact Us](#)

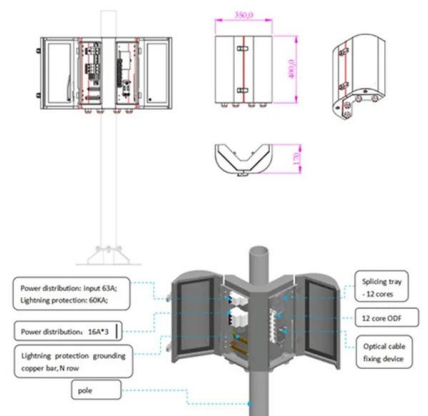

### Mali : 117 millions de dollars pour étendre le réseau de

Accueil » Afrique de l'Ouest » Mali : 117 millions de dollars pour étendre le réseau de fibre optique et ajuster le projet Mali numérique. Le

[Contact Us](#)

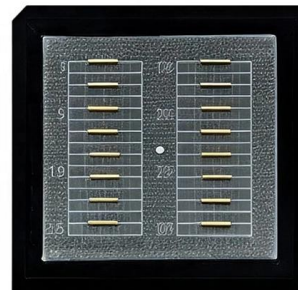

### Trans-Saharan Optic Fibre Broadband Project

Additionally, this project aims to deploy a high-capacity terrestrial fiber optic corridor across the Sahara Desert, connecting Algeria, Niger, Chad, and Nigeria. It is part of a regional digital transformation

[Contact Us](#)

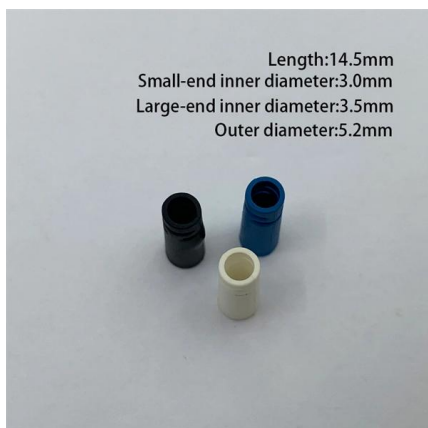



### **Mali's 817 km optical fiber network project has received a loan from**

The \$162m project, to be implemented by China international telecommunications construction corporation (CITCC), is expected to be completed within two years.

[Contact Us](#)



### **Mali Partners with Huawei to Speed Up Digital Transformation**

The fiber optic expansion project, managed by CITCC and valued at \$117.3 million, was approved by the government in January. It covers the regions of Mopti, Koro, Timbuktu, Gao, Ansongo, and

[Contact Us](#)



### **Guinea and Mali Sign Fiber Optic Interconnection Agreement**

Guinea and Mali have agreed to interconnect their respective fiber optic networks, aiming to bolster their national infrastructures. Currently, Guinea relies on a single international submarine fiber optic cable

[Contact Us](#)



### **Fiber Optic Cable Manufacturing Plant Cost, DPR 2026**

Fiber Optic Cable Manufacturing Plant Project Report (DPR) Summary: IMARC Group's comprehensive DPR report, titled " Fiber Optic Cable Manufacturing Plant Project Report 2026: Industry Trends,

[Contact Us](#)

### **Fiber Optic Project Estimator , Progressive**



## Office Cabling

Fiber Optic Project Cost Estimator Typically, per drop fiber cabling prices range from \$250 - \$1000 per drop depending on the type of fiber (OM2, OM3, OM4, or

[Contact Us](#)

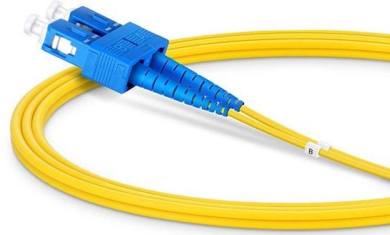

## Mali awards \$117.3m fibre optic network expansion contract to CITCC

IN a significant move towards advancing digital connectivity, the government of Mali has reportedly granted a contract worth \$117.3 million to the China International Telecommunication Construction

[Contact Us](#)

## How Much Does It Cost to Run Fiber Optic Cable per

Direct burial: \$1-\$6 per linear foot (simple installations only) Prices can range from \$1 to \$50+ per linear foot depending on the method and

[Contact Us](#)



## 4K Fiber KVM Extender up to 550m for Remote PC

AV Access 4KIP500F-KVM fiber KVM extender, transmitting 4K HDMI and USB signals up to 550m/1800ft with zero latency. Works with an Ethernet switch to

[Contact Us](#)



## Extending the Reach and Reducing the Costs of

The West Africa Regional Communications Infrastructure Program (WARCIP) Project helped to increase the geographical reach of broadband networks and reduce the

[Contact Us](#)



## Robust Solutions For Terrestrial Optical Fiber Network Mali

Additionally, we offer highly dependable services terrestrial optical fiber network in Mali Our satellites supporting Mali include Telstar 11N, Africasat 1A, ABS-2, Arabsat 5C and NSS-12.

[Contact Us](#)



## IFC Invests in Orange Mali to Expand Digital

The partnership aims to roll out sustainable digital infrastructure projects across eight countries in West and Central Africa, expanding affordable

[Contact Us](#)



## Fiber KVM Extender

ServSwitch Dual DVI Single-Mode Fiber Optic KVM Extender, USB For computers with dual video heads, extend signals over single-mode fiber.

[Contact Us](#)





### The keys to deploying fiber networks faster and cheaper

Four tactics can improve telecom companies' returns on fiber rollouts, helping to connect more of the millions of people who remain without high-speed

[Contact Us](#)



### World Bank Document

Project information: Mali - Implementing a PPP to sell excess capacity of the Sogem fiber optic network to improve regional connectivity - P159688 Project Implementation agency: Société de Gestion de

[Contact Us](#)

### Mali invests US\$117.3 million in fibre

The Malian government has entrusted the extension of the national fibre optic network to China International Telecommunication Construction Corporate. With a total cost of US\$117.3 million,



[Contact Us](#)

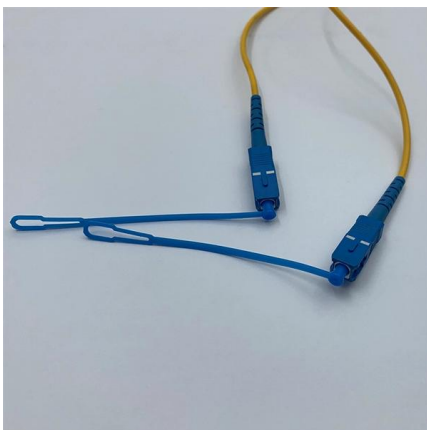

### Mali govt invests \$117.3bn to improve fiber optic network

The Malian government has initiated a project to extend the national fiber optic network. The contract was awarded to the Chinese company China International Telecommunication Construction

[Contact Us](#)



### **African Development Bank approves \$22.5m financing for Mali's digital**

The project which costs \$37 million has the AfDB as the largest financier. The Malian government will contribute \$3 million and the French development agency will also contribute \$11.5

[Contact Us](#)



### **CONSIDERATIONS FOR FIBER**

**CONSIDERATIONS FOR FIBER-BASED KVM EXTENSION** If you're sending KVM signals between buildings for an extended distance, in areas supplied by different power sources, in an electrically e

[Contact Us](#)

### **Fiber Optic Coverage and Internet Usage Statistics in Mali (2026)**

These projections for Mali are derived from cross-referencing publicly available government data, industry reports from organizations such as the ITU, World Bank, and Statista, and historical trend

[Contact Us](#)



## **Contact Us**

---

For datasheets, pricing, or custom fiber access solutions, please visit:  
<https://frindel.es>