

Parallel installation of household distribution box switches

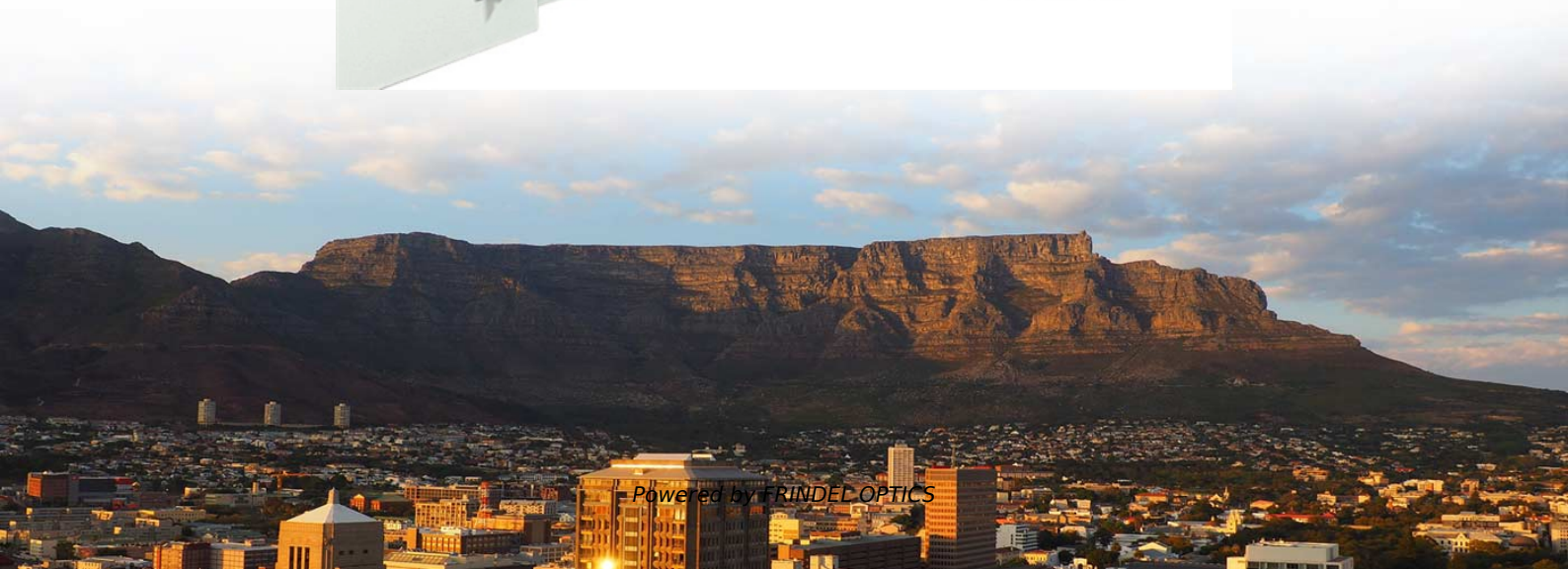

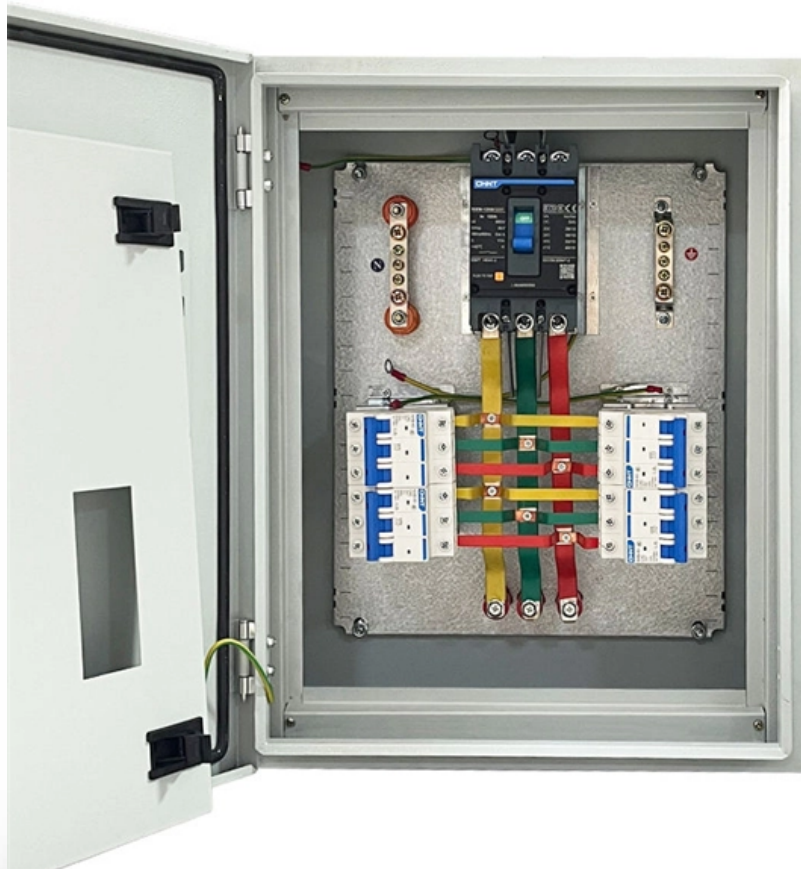

Parallel installation of household distribution box switches

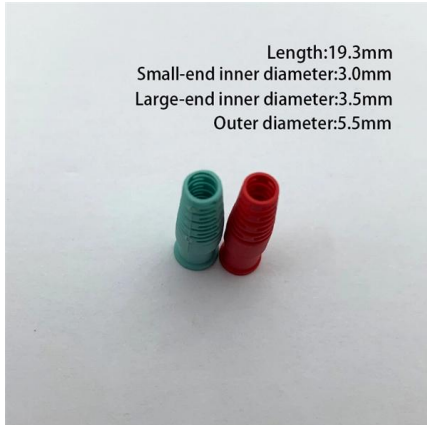

on video How to Wire a Home Distribution Box

How to Wire a Home Distribution Box - Step-by-Step , Distribution DB box wiring diagram
Welcome to our channel! In this video, we'll walk you through the

[Contact Us](#)

How to Wire a Home Distribution Box

In this video, we'll walk you through the process of wiring a home distribution box with a detailed connection diagram. Whether you're an electrician or a DIY

[Contact Us](#)



Understanding Distribution Boxes: A Comprehensive Guide

support safer operation in electrical systems For this reason, distribution boxes are widely used in homes, commercial buildings, industrial

[Contact Us](#)

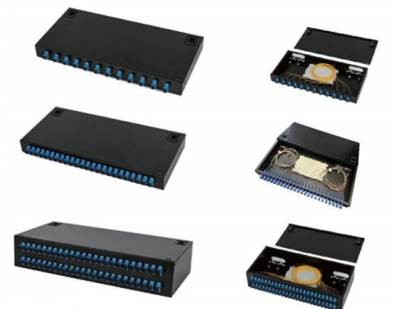

Electrical Wiring 101: A Beginner's Guide to House Wiring

Basic Components of House Wiring To guarantee a safe installation, let's break down the key parts of electrical wiring. Electrical Service Panel

[Contact Us](#)



Single Phase Distribution Box (DB) Wiring Diagram and

Hey, in this article we are going to see the Single Phase Distribution Box Wiring Diagram and Connection Procedure. A distribution board or

[Contact Us](#)



How to Wire a Switch Box ? Electrical Switch Board

Power point wiring diagram A power point wiring has a circuit similar to a normal 3 pin socket connection with switch control. But unlike a normal

[Contact Us](#)

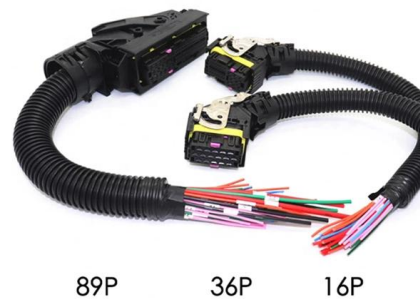

Electrical Receptacle Wiring in Parallel vs Daisy-Chaind How to wire

Here we compare wiring an electrical receptacle wired "daisy chained" from one to another (the most-common practice) with wiring receptacles in parallel on an electrical circuit. Wiring in parallel gives

[Contact Us](#)





DIY Wiring a Consumer Unit and Installation

/ Consumer Unit Background Wiring a Distribution Board is vital in any electrical installation. All the electrical sub circuits are originated from a Distribution

[Contact Us](#)



Brief Introduction To The Installation Method Of

If it is installed in the household distribution box, you need to buy the household line, which has nearly 4 million square meters, and is connected to the

[Contact Us](#)

The Complete Guide to Distribution Box: Installation, Types & More

High-usage commercial and industrial installations may require more frequent inspections based on operating conditions and manufacturer recommendations. Can I add circuits to an existing

[Contact Us](#)

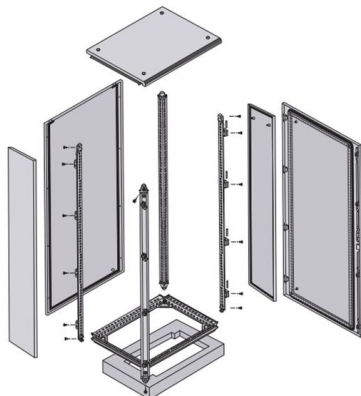
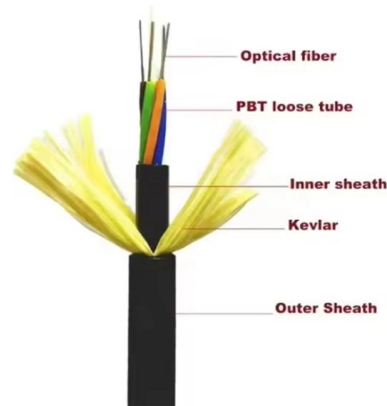

"Guidelines for Household Distribution Box Specifications and

Installing a household distribution box requires careful attention to specifications and safety guidelines. Understanding these parameters is vital for ensuring the safety and efficiency of

[Contact Us](#)

The installation requirements for the



distribution box

A distribution box is the heart of any electrical system. It takes the incoming power and safely distributes it to different circuits throughout your

[Contact Us](#)



Multiple Receptacle Outlets Wiring Diagrams

Clear, easy-to-read wiring diagrams for connecting multiple receptacle outlets in a row, including GFCI and Duplex Receptacles.

[Contact Us](#)

X3-EPS+Parallel Box (5pcs) Installation Guide-EN

There are three work modes in parallel system, and your acknowledge of different inverter's work modes will help you understand parallel system better, therefore please read it carefully before operating.

[Contact Us](#)



The installation requirements for the distribution box

Learn how to install a distribution box safely and correctly. Covers wiring, placement, standards, and expert tips for a compliant setup.

[Contact Us](#)



How to Wire Lights in Parallel? Bulbs Connection in

How to Connect Light Points in Parallel ? The common household circuits used in electrical wiring installations are (and should be) arranged in parallel. Typically,

[Contact Us](#)



How to Wire a Switch Box ? Electrical Switch Board

In the below wiring diagram, the phase line is connected parallel to the light switch and the plug socket switch. Here, one pole of the both SPST (single

[Contact Us](#)

How to Wire a Home Distribution Box

How to Wire a Home Distribution Box - Step-by-Step , Distribution DB box wiring diagram
Welcome to our channel! In this video, we'll walk you through the

[Contact Us](#)



DIY Wiring a Consumer Unit and Installation

Here we are considering a Distribution Board with MCBs [Miniature Circuit Breakers] for power distribution. Installation work described here is according to British

[Contact Us](#)



Wiring of the Distribution Board From Energy Meter to

How to Wire a Distribution Board? Distribution Board also known as "Panel Board", "Switch & Fuse Board" or "Consumer Unit" is a box installed in the building

[Contact Us](#)



How To Connect The Household Distribution Box? How

This connection method has a proprietary name in the distribution box-jumper. In order to better let everyone understand "jumper", let's take a look

[Contact Us](#)

Supply of Electricity

This meter records the electricity consumed by the house in kilowatt hour (kwh). The wires from the electric meter pass to the distribution box and are distributed to

[Contact Us](#)



Home Distribution DB Box Wiring Connection Diagram , DB box wiring

Whether you're an electrician or a DIY enthusiast, this tutorial will help you understand the fundamentals of wiring a distribution box for a residential setup.

[Contact Us](#)



Basic Electrical Parts & Components of House Wiring

Learn how 9 basic electrical parts often seen in your household circuit. See how Fuse, Trip, Main Switches create the final house wiring circuit together.

[Contact Us](#)



Electrical Wiring, House Wiring or Home Wiring

Single phase energy meter is connected with pole which receives 220V supply from the step-down distribution transformer. The energy meter is then

[Contact Us](#)



How to Install a Cable Distribution Box Safely and

In modern electrical systems, cable distribution boxes (also known as electrical distribution boxes or distribution boxes) play a crucial role as the key

[Contact Us](#)



Contact Us

For datasheets, pricing, or custom fiber access solutions, please visit:
<https://frindel.es>