

# **Nepal Outdoor Integrated Power Supply Solution 100kWh**





## Nepal Outdoor Integrated Power Supply Solution 100kWh

---



### 100KW/215KWh All-in-One Outdoor Lithium Inverter

Our solution is an all-in-one package: Battery packs, charge controller, BMS, EMS, and PcS, all integrated into a single unit with a highly efficient three-level topology

[Contact Us](#)

### TSN ,, Team Sinergy Nepal

We carefully select our supplier and partners by examining the performance and the lifecycle of the products. We only believe in offering quality products at affordable

[Contact Us](#)

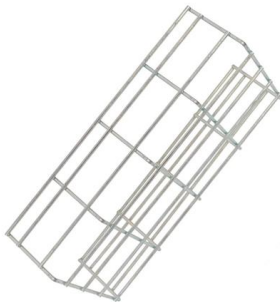

### Solar Irrigation in Nepal

Around 2015, solar-powered pumps emerged as a potential solution for drinking water and irrigation in rural Nepal. The decentralised nature of technologies made it ideal for reaching farmers who lacked

[Contact Us](#)

### Bess Outdoor Energy Storage Power Supply 100Kwh

Sunark outdoor ESS cabinet offers IP54 protection, 215kWh capacity + 100kW output, modular design, 480-700V wide voltage, 125A peak current, integrated



### **Outdoor Power Supply Factories in Kathmandu: Meeting Nepal's**

Looking for reliable outdoor power solutions in Nepal? Kathmandu's factories are stepping up to address energy challenges through innovative solar and battery storage systems. This guide explores the

[Contact Us](#)

### **Nepal Energy Outlook 2022**

Agreement between the government of Nepal and the government of the Republic of India on electric power trade, cross-border transmission interconnection, and grid connectivity.

[Contact Us](#)



### **Adequacy Assessment of Integrated Nepal Power System**

Author Keywords. INPS, Integrated Nepal Power System, LOLE, Loss of Load Expectation, EENS, Expected Energy not Supplied, NEA, Nepal Electricity Authority.

[Contact Us](#)





## Outdoor ODM BESS Energy Storage System , 50

Looking for an ODM BESS energy storage system? Our all-in-one outdoor cabinet (50-100kWh) features an IP55 design, LFP cells, and easy expansion for C& I

[Contact Us](#)



## 50kW / 100kWh LiFePO4 C& I HV Outdoor Solar Battery

Introducing our 50kW / 100kWh high-voltage outdoor energy storage solution designed for commercial and industrial (C& I) applications.

[Contact Us](#)



## 10KW Off Grid Solar System Complete Kit 10KWH Kit Nepal , Ubuy

Shop 10KW Off Grid Solar System Complete Kit 10KWH Kit Home Solar Power System Complete Kit with 16PCS550W Solar Panels,1Sets 48V 10KW Off Grid Inverter, 1Sets 10KWH 51.2V 206Ah

[Contact Us](#)



## 10KW Off-Grid Solar System Complete Kit 48V Home Nepal , Ubuy

Shop 10KW Off-Grid Solar System Complete Kit 48V Home Solar Power System Complete Kit with Solar Panels Solar Inverter Solar Battery 5KWH 10KWH 16KWH 8pcs580W PV 10KW Inverter5Kwh

[Contact Us](#)



### **Nepal solar energy storage cabinet 100kWh**

This integrated solar battery storage cabinet is engineered for robust performance, with system configurations readily scalable to meet demands such as a 100kwh battery storage requirement.

[Contact Us](#)



### **100kW/215kWh Integrated PV Storage and Charging**

The 100kW/215kWh Integrated PV Storage and Charging Solution combines solar power generation, energy storage, and electric vehicle (EV) charging into one

[Contact Us](#)

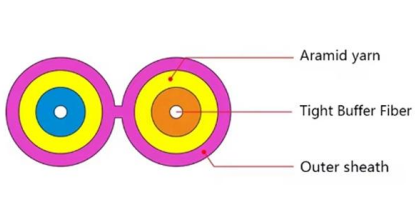

### **Image Integrated - Energy Source Items Supply in Nepal**

It converts DC battery power into AC power, ensuring uninterrupted operation for computers, servers, and other electronic devices. With

[Contact Us](#)

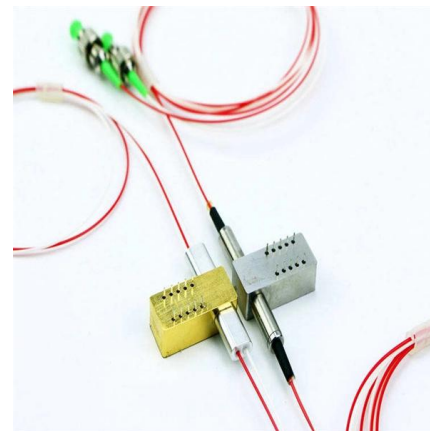

### **Nepal Power Solution -- Powering Nepal with Clean Energy**

Nepal Power Solution -- Leading energy solution provider since 2009. Solar, lighting, IT & security, and infrastructure solutions.

[Contact Us](#)





## buy PCS Cabinet 100KWH 200KWH Outdoor Container Cabinet

We are best PCS Cabinet 100KWH 200KWH Outdoor Container Cabinet BESS LFP Storage Lithium Battery with ESS Solution suppliers, we supply best container cabinet 100kw battery for sale.

[Contact Us](#)



2. Imported design is convenient for expansion.

The design of two inlets saves space and allows for rear line entry.

## Nepal solar energy storage cabinet 100kWh

SWB POWER & SOLAR provides advanced battery energy storage systems (BESS), outdoor integrated cabinets, PCS, industrial battery storage, cloud energy management, frequency regulation storage,

[Contact Us](#)

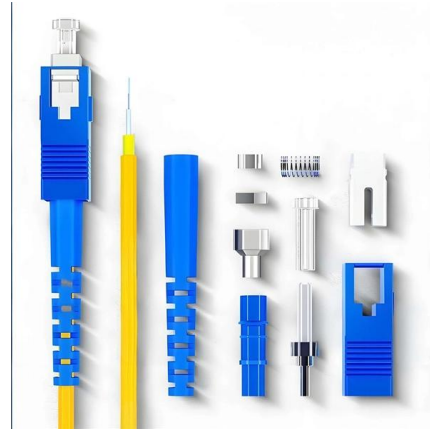

## Solar Power Generation System 5KWh 10KWh Stacked Nepal , Ubuy

Shop Solar Power Generation System 5KWh 10KWh Stacked Lithium Battery Energy Storage and Off-Grid Inverter Power Supply Integrated Machine, Applicable to Courtyard, Garage and Equipment

[Contact Us](#)



## Jackery Explorer 2000 Plus Kit (6kWh)+Manual Nepal , Ubuy

Easy Integration: Featuring pre-wired, easy installation and Plug & Play functionality, the Jackery Home Backup Power System that's composed of both a Solar Generator 2000 Plus and a manual Transfer

[Contact Us](#)



Inverter - Solar Inverter - Hybrid Energy Storage Inverter - Off Grid Inverter - On Grid Inverter - Nepal - Kathmandu - energyNP Energy Nepal- Complete Power

[Contact Us](#)



### buy PCS Cabinet 100KWH 200KWH Outdoor Container Cabinet

Greensun can provide industrial and commercial users with a complete solution of outdoor integrated PV& energy storage system. It can be widely used in scenarios such as charging stations, factories,

[Contact Us](#)



### Where to Buy Outdoor Power Supply in Nepal: A Complete Guide

Where to Buy Outdoor Power Supply in Nepal: A Complete Guide Looking for reliable outdoor power solutions in Nepal? Discover top suppliers, product types, and industry trends to power your

[Contact Us](#)

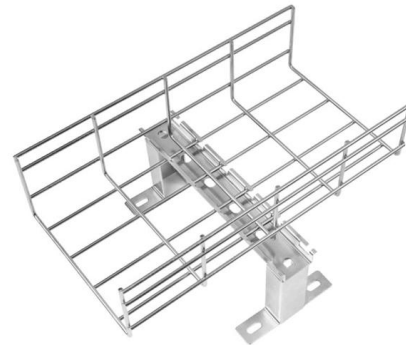

### Solar Energy in Nepal: A Complete Guide for 2025

Solar energy in Nepal is more than just a trend -- it's a sustainable solution to power the nation's future. Whether for homes, businesses, or communities, investing in solar brings financial

[Contact Us](#)





## Energy Nepal-Complete Power Solution

We are a professional energy information platform in Nepal, providing information on energy products, bidding, projects, domestic and international markets and exhibitions.

[Contact Us](#)

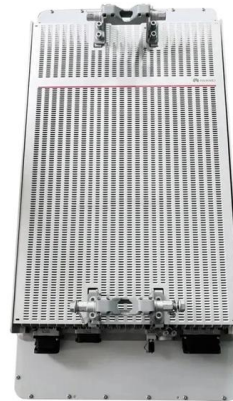

## Best Inverter in Nepal (2025)

Best Inverter in Nepal (2025) - Reliable Backup Power Solutions by Fortuners Power interruptions and unreliable electricity supply are common in many parts of Nepal. Whether you live

[Contact Us](#)

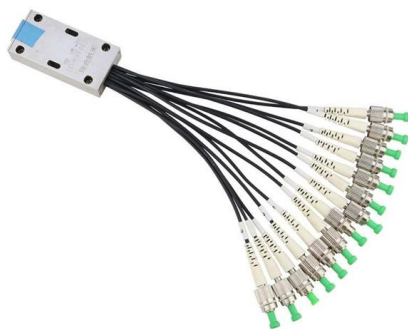

## Solar LiFePO4 100kwh Battery

For remote areas and small islands, where public grid infrastructure

[Contact Us](#)

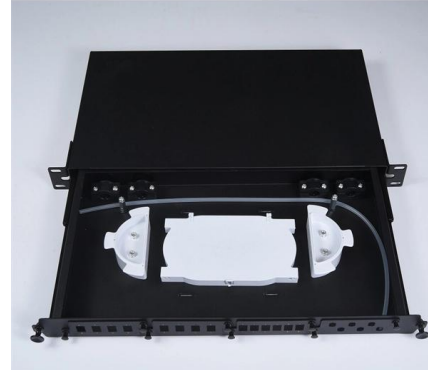

## Image Integrated - Energy Source Items Supply in Nepal

Energy Image Integrated manufactures a range of energy solutions, including online UPS for key applications in industry and achieving

[Contact Us](#)





## Nepal's Solar Power Potential is 432 GW, Tenfold

Despite the significant progress in hydropower development, it is clear that solar power potential has now surpassed it. Factors such as the ongoing

[Contact Us](#)



## Industrial Outdoor Power Supply with 100 kWh Storage Capacity: The

Summary: Discover how industrial outdoor power supplies with 100 kWh storage capacity are revolutionizing energy management across industries. Learn about their applications, cost-saving

[Contact Us](#)

## Contact Us

---

For datasheets, pricing, or custom fiber access solutions, please visit:  
<https://frindel.es>