

Mesh cable tray climbing bend





Mesh cable tray climbing bend



Wire Mesh Cable Tray System

Wire Mesh Cable Tray System for Channeling of Cable Wiring A Simple-to-Install basket cable tray for safe and proper installation of facility wiring in the ceiling and under the floor.

[Contact Us](#)

Extending Your Wire Mesh Basket or Cable Tray System Made

Learn how to easily extend a wire mesh basket or cable tray system with tips on bends, risers, dividers, covers, and support solutions.

[Contact Us](#)

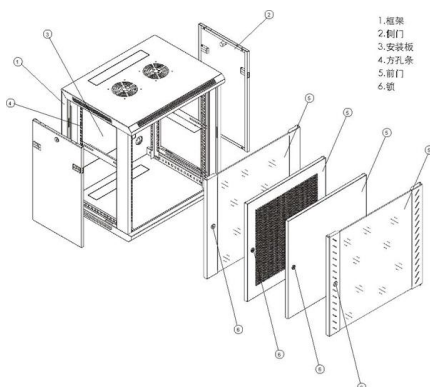

How to make a bend on an open cable tray

This video shows you how easy it is to form and bend an open cable tray from SILTEC - suitable for cables and pipes. See how easy it is to cut the threads away and bend the tray. For more details

[Contact Us](#)

How to Bend FLEXTRAY Wire Basket Cable Tray

The tray can be cut and bent, allowing cable runs to be adjusted on the jobsite. The market-preferred "T" weld safety-edge protects the cable and the installer during installation.

[Contact Us](#)

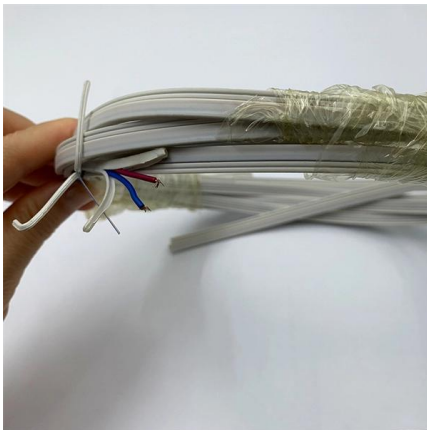

Types of Bends in Wire Mesh Cable Trays: A Detailed

Understanding the different types of bends in wire mesh cable trays is key to achieving a successful and efficient installation. Each bend type serves a

[Contact Us](#)

Mesh cable tray bends , OBO

Mesh cable trays, screw connection fittings - Mesh cable tray bends.

[Contact Us](#)



How to make a bend with a wire mesh cable tray

This video shows you how easily, you can form and bend a wire mesh cable tray from Siltec - suitable for cables and tubes. See how easy it is to cut away the

[Contact Us](#)



CabloBend EZ



Cablobend Systems give you the freedom for true cable tray flexibility. Create bends and drops that you need--without cutting. Perfect for data centers.

[Contact Us](#)



Mesh cable tray systems

4 1 Product description OBO mesh cable tray systems stand out through their high load capacity and good ventilation. They can be used universally. The mesh cable trays are suitable for the installation

[Contact Us](#)

Assembly Guide

The assembly guide below will help the cable tray installer make the bends and others without difficulty even he had never installed wire mesh cable trays before. Guide for making bends, tees, crosses,

[Contact Us](#)



Mesh cable tray systems

4 1 Product description OBO mesh cable tray systems stand out through their high load capacity and good ventilation. They can be used universally. The mesh cable trays are suitable for the installation

[Contact Us](#)



Wire Mesh Cable Tray Vertical Outside Bend

A wire mesh cable tray vertical outside bend is a fitting used to change the direction of a wire mesh cable tray system vertically, typically at a 90-degree angle,

[Contact Us](#)

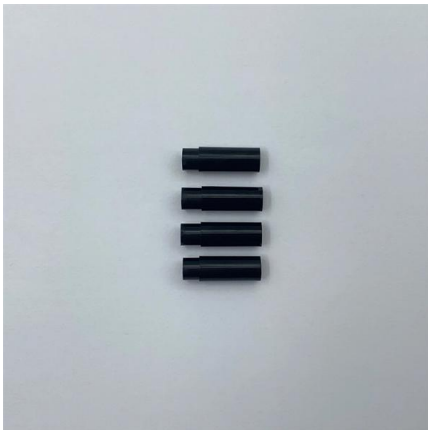

Cable Tray Bends

Heavy Duty 90 Degree External Bend 75mm £ 21.89 ex. VAT - £ 26.27 inc. VAT Heavy Duty 90 Degree Flat Bend 100mm £ 27.76 ex. VAT - £ 33.31 inc. VAT

[Contact Us](#)

CABLE TRAY SYSTEM

CABLE TRAY TRAY CUTTING & SYSTEM BENDING GUIDES CONFIGURING CABLE TRAYS FOR INSTALLATION CROSS-JOINT: SQUARE CORNER

[Contact Us](#)

Product Photography

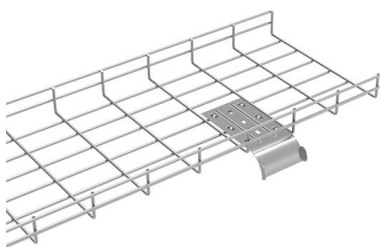

CabloBend EZ

With Cablobend Systems, you have the freedom to flexibly create the bends and drops that you need. No more cutting unless shortening the length.

[Contact Us](#)



WIRE MESH CABLE BASKET installation 2014v01.xls

To field cut and form a bend from a Wire Basket straight section, cut side and bottom wires (deburr if necessary). Form and assemble using recommended Connector Assemblies as illustrated below. ue



[Contact Us](#)



Metalix Cable Trays

Crafted from premium materials such as galvanized steel, aluminum, and stainless steel, our bends are designed to withstand heavy loads, resist corrosion, and

[Contact Us](#)

7 Types of Cable Trays: How to Choose the Right One

Cable tray systems are engineered support structures designed to route, support, and protect insulated electrical cables used for power distribution,

[Contact Us](#)

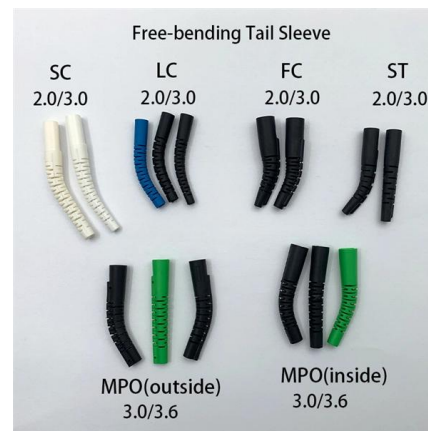

Bend for mesh cable tray

90° mesh cable tray bend G. 90° bend, horizontal, for all mesh cable trays of 105 mm side height. All ratings we receive from the items we offer are real and verified. A small gesture, but a lot of value.

[Contact Us](#)

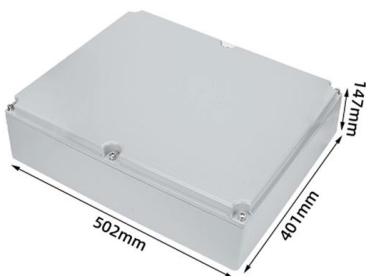



Cable Tray and Reels , Wire and Cable Management

Fast installation with dependable support. Everything you need to build a cable management system, including Cablofil wire mesh cable tray, ladder cable tray,

[Contact Us](#)

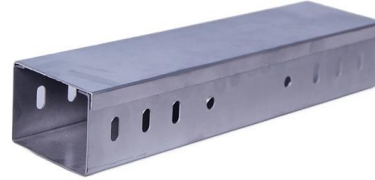

WIRE MESH CABLE TRAYS - Demka Electrical Suppliers

Wire mesh cable trays are made by compounding wire cable conduits with horizontal wires running vertically every 100 mm and vertical wires running horizontally every 50 mm.

[Contact Us](#)

Mesh cable tray bends

Discover mesh cable tray bends from OBO Bettermann & find the right solution for your project! OBO - Your supplier for electrical installation

[Contact Us](#)

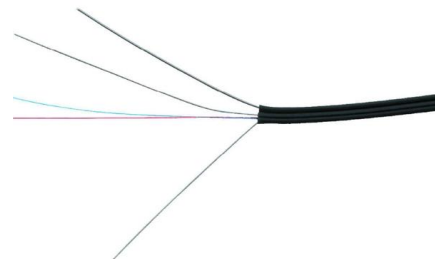

90° mesh cable tray bend G , OBO

Find out more about 90° mesh cable tray bend G 100 , 3.9 , no now! OBO - your provider for Cable support systems.

[Contact Us](#)





Mesh cable tray systems

Mesh cable tray systems Mounting instructions © 2020 OBO Bettermann Holding GmbH & Co. KG Reprinting, even of extracts, as well as photographic or electronic reproduction are prohibited! Table

[Contact Us](#)



Mesh cable trays , OBO

Mesh cable trays, screw connection fittings
Connectors Cover Accessories, mesh cable trays

[Contact Us](#)

90° mesh cable tray bend G , Trench

Find out more about 90° mesh cable tray bend G now! OBO - your provider for Accessories.

[Contact Us](#)



Cable Exit Clip/Dropout Waterfall for Wire Mesh Cable

Maintain the perfect bend radius when dropping cable bundles through the bottom of your wire mesh cable tray. This rugged metal cable exit clip is 45 mm wide.

[Contact Us](#)



Exploring the Different Bending Types for Wire Mesh

Wire mesh cable trays have become a vital component in modern electrical installations, offering flexibility, durability, and easy customization for

[Contact Us](#)



Contact Us

For datasheets, pricing, or custom fiber access solutions, please visit:
<https://frindel.es>