

Main line connected to distribution box

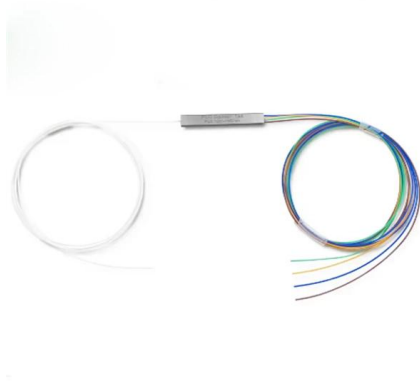



Main line connected to distribution box



MCB Box Full Wiring Connection Explained , Inverter to Main Line , A

Welcome to Electric Work Centre! In this video, we're diving deep into the complete wiring connection of an MCB box -- from A to Z.

[Contact Us](#)

The basics of primary distribution circuits (substation)

Some distribution primaries are three-wire systems (with no neutral). On these, single-phase loads are connected phase to phase, and single-phase

[Contact Us](#)



Primary and secondary power distribution systems (layouts explained)

Find out how to properly wire an electrical panel box with a comprehensive diagram and step-by-step instructions.

[Contact Us](#)



How to Wire 3-Phase, 400V Distribution Board? IEC

Wiring a 3-Phase, 400V Distribution Board: UK & EU - IEC. How to Wire a Three-Phase Distribution Board for 400V Load Circuits and MCB's?

[Contact Us](#)

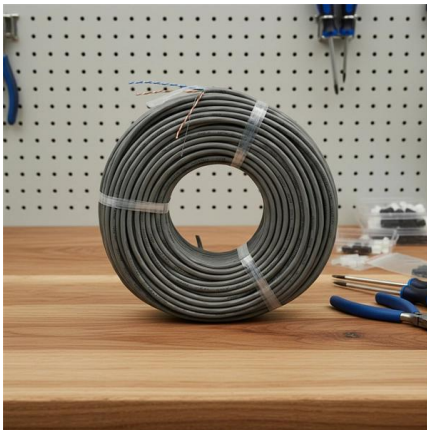

A Guide to Wiring a Main Breaker Box

Once all the wiring has been done inside the main breaker box, it is important to connect the wires properly and test the system to ensure everything is functioning

[Contact Us](#)

How to wire a DB - Distribution Board Wiring -

Through the MCB phase lines are distributed to electrical wiring for lighting, fixed devices, and power distribution points. This type of arrangement is

[Contact Us](#)

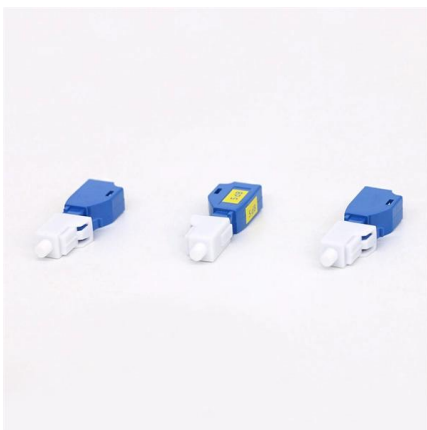
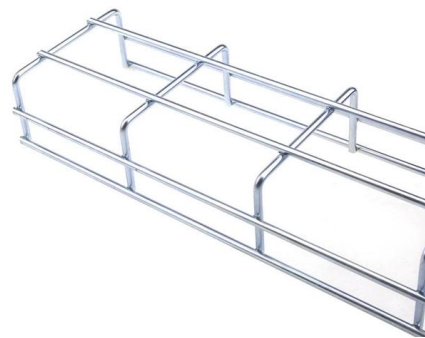

Distribution Box Installation: A Complete Guide to Safe

The distribution box, often referred to as a breaker box, fuse box, or electrical panel, is a critical component of any electrical system. It acts as the central hub for

[Contact Us](#)



Wiring of the Distribution Board with RCD (Single Phase)

Electrical Wiring Installation of the Distribution Board with RCD (Single Home Phase Supply From Utility Pole & Energy Meter to the Consumer Unit. How to Wire RCD

[Contact Us](#)



Single Phase Distribution Box (DB) Wiring Diagram and

Hey, in this article we are going to see the Single Phase Distribution Box Wiring Diagram and Connection Procedure. A distribution board or

[Contact Us](#)

How to connect the electrical distribution box and the main electrical

Note: The door of the main electrical distribution box and the box must be reliably connected with braided soft copper wire as the safe distance for protective neutral connection and five wire erection.

[Contact Us](#)

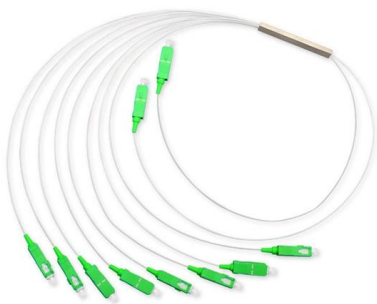
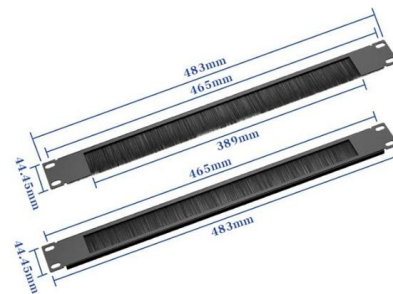

Understanding Circuit Breaker Wiring Configurations in

Live (L) Wire Connection: In a distribution box setup, the incoming live wire (also known as phase or hot wire, denoted as L or Line) connects to the line

[Contact Us](#)



How to Wire 120/240V Main Panel

These three wires enter the meter box and then connect to the main panel. In the following tutorial, we will show how to wire 120V single-phase and 240V split

[Contact Us](#)



How to Wire a Home Distribution Box

In this video, we'll walk you through the process of wiring a home distribution box with a detailed connection diagram. Whether you're an electrician or a DIY

[Contact Us](#)

The Complete Guide to Distribution Box: Installation, Types & More

What's the difference between a distribution box and a sub-panel? A distribution box typically refers to the main electrical panel that receives power from the utility service. A sub-panel is

[Contact Us](#)

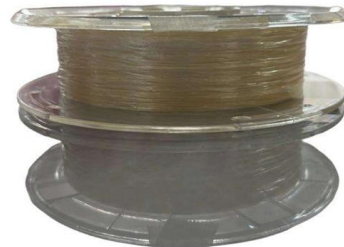

Single-line diagram of AC transmission and distribution

Transmission and distribution The conductor system by means of which electric power is conveyed from a generating station to the consumer's

[Contact Us](#)



How can the distribution box be connected

When we use the distribution box, we need to consider how the distribution box can be connected, especially when we use the distribution box at home. If you are

[Contact Us](#)



complete distribution db box connection

A distribution board DB is where the electrical supply is distributed from within the building home. The main supply cable comes into the board and is then d

[Contact Us](#)



Atlantic International University

Hier sollte eine Beschreibung angezeigt werden, diese Seite lässt dies jedoch nicht zu.

[Contact Us](#)

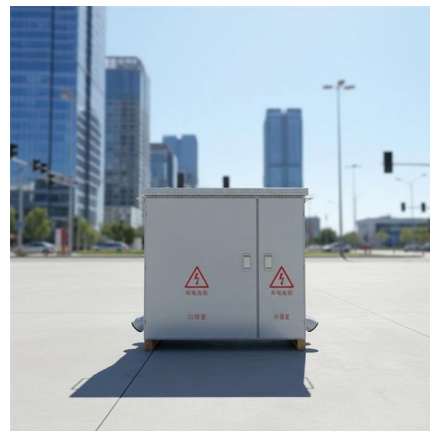

Size determination, installation method and wiring mode

The distribution box is the central hub of the home circuit and the general control of our daily power consumption. It is an indispensable electrical equipment. If there

[Contact Us](#)



How to Install a Cable Distribution Box Safely and

In modern electrical systems, cable distribution boxes (also known as electrical distribution boxes or distribution boxes) play a crucial role as the key

[Contact Us](#)



Distribution Box: Types and Functions , Axis-Electricals

A distribution box houses all the contact breakers, earth leakage units, doorbells, and timers. The electrical power supply comes from the network to the building

[Contact Us](#)

A Step-by-Step Guide to Wiring an Electrical Panel Box

A Step-by-Step Guide to Wiring an Electrical Panel Box An electrical panel box, also known as a breaker box or a distribution board, is a crucial component of any

[Contact Us](#)



How Does a Power Distribution Box Work

Learn how a power distribution box works step by step--from incoming power to circuit protection and smart monitoring--for safe, efficient electricity delivery.

[Contact Us](#)



Visual Guide to Main Electrical Panel Wiring

Learn how to read and understand a main electrical panel wiring diagram to troubleshoot and make repairs in your home or business.

[Contact Us](#)

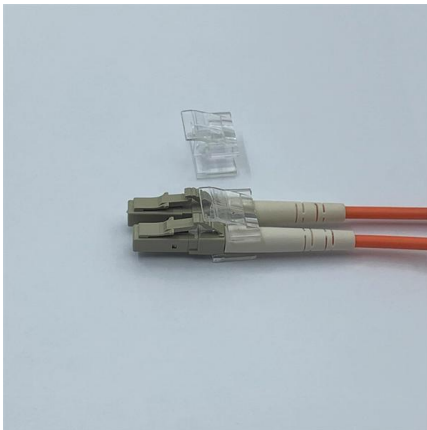

The Complete Guide to Wiring Diagrams: From Meter to

Learn how to read and understand a wiring diagram from the electric meter to the breaker box in order to troubleshoot and fix electrical problems in your home. Get

[Contact Us](#)

How To Connect A Distribution Box

Learn how to connect a distribution box with this easy-to-follow, step-by-step guide. From tools and materials needed to common installation mistakes and solutions, this comprehensive article will

[Contact Us](#)

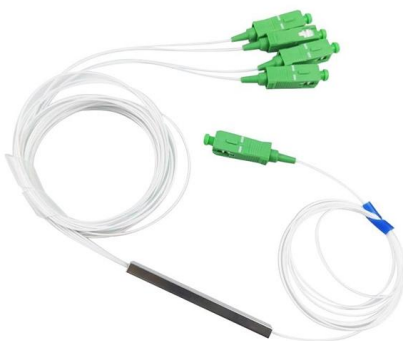

How to Wire a Home Distribution Box

How to Wire a Home Distribution Box - Step-by-Step , Distribution DB box wiring diagram Welcome to our channel! In this video, we'll walk you through the

[Contact Us](#)



Contact Us

For datasheets, pricing, or custom fiber access solutions, please visit:
<https://frindel.es>