

Iranian Aggregation Switch 400G





Iranian Aggregation Switch 400G



2023-050-AGR400_AS7946-30XB DS R05 20230524

AGGREGATION ROUTER AS7946-30XB The AGR400 is a high-performance 100GbE aggregation router that consists of fixed 2 x 400G QSFP-DD (21.3 W), 2 x 400G QSFP-DD (16.5 W), 4 x 100G

[Contact Us](#)



400Gb Data Center Switches

FS 400G data center switches offer high speeds and port densities to meet the network deployment requirements of various scenarios and the evolving requirements of next-generation data center

400G Ethernet Network Gigabit Switches

FS launches 400G Ethernet Switch to cater for industry leading 400G rate, future development trend and Open Network Install Environment (ONIE), which offers you rich choice of port speed and density

[Contact Us](#)



Cisco Nexus 9000 Series 400G Deployment Guide

Cisco Nexus 93600CD-GX Cisco and Panduit 400G wiring scenarios The following scenarios in this section present the high-level cabling and optics

[Contact Us](#)

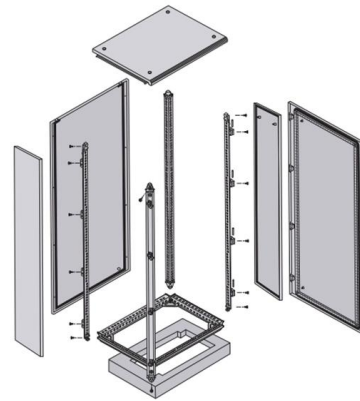

Specification Sheet DELL POWERSWITCH

The Z9332F-ON 100/400GbE fixed switch comprises Dell Technologies' latest disaggregated hardware and software data center networking solutions, providing state-of-the-art, high-density 100/400 GbE

[Contact Us](#)

Cisco ASR 9000 Series 400G and 200G Modular Line Cards Data Sheet

Product overview The Cisco ® ASR 9000 Series 400G (Figure 1) and 200G Modular Line Cards provide customers with a highly flexible solution. They support multiple combinations of

[Contact Us](#)

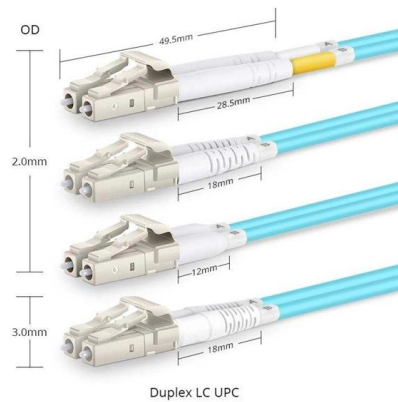

AGR560

The AGR560 is a high-performance 400GbE aggregation router that consists of fixed 12 x 400G QSFP-DD (23 W) and 24 x 100G QSFP28 (6.5 W) network interfaces

[Contact Us](#)

Edge-Core AS7946-30XB AGR400 ONIE



Aggregation

The Edge-Core AS7946-30XB AGR400 is a high performance 2.4T aggregation router loaded with ONIE and compatible with IP Infusion and other NOSes.

[Contact Us](#)

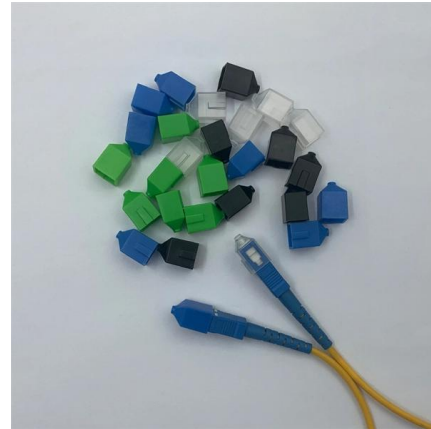

400G Optical Transceivers , OEM Compatibility

Discover the power of 400G QSFP-DD Optical Transceivers--ultra-fast, energy-efficient, and future-proof solutions.

[Contact Us](#)



High-Bandwidth Aggregation Switch 400Gbps

High-Bandwidth Aggregation Switch 400Gbps, Achieve greater efficiency and speed with Layer 3 managed switches equipped with 10G uplink. Perfect for demanding environments where

[Contact Us](#)



AI Switches for 100G/200G/400G and 800G Ports By

Each block comprises a group of GPU servers and 400G switches (such as 16 DGX H100 systems with 8 CX732Q-N switches). Rail-aligned, non

[Contact Us](#)

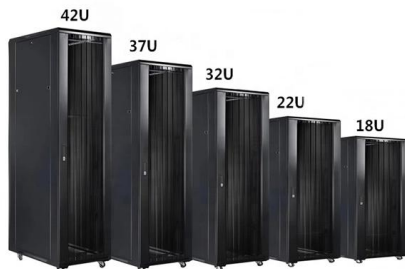



Sale of electrofusion welding machine up to 400 mm

Iranian Company -

Sale of electrofusion welding machine up to 400 mm

Suitable for welding gas, water and acid transmission lines from size 25 to 400 mm

[Contact Us](#)



APCON IntellaView 400G EdgeSwitch , Network

APCON's IntellaView 400G EdgeSwitch Datasheet , The new IntellaView 400G EdgeSwitch is a powerful but small form-factor switch that is ideal for deploying in

[Contact Us](#)

UfiSpace S9610-36D Aggregation Router

The UfiSpace S9610-36D is a 36x400G open aggregation router designed to support service providers as they transition their networks to 400G and 5G.

[Contact Us](#)

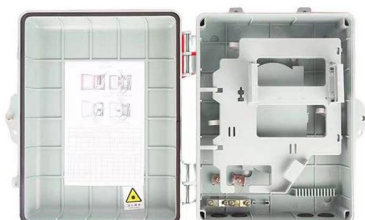

MikroTik · CRS804 DDQ

A compact 1U 400G switch built for AI clusters, storage fabrics, and high-speed aggregation, featuring four 400G QSFP56-DD ports, dual 10 Gigabit Ethernet,

[Contact Us](#)



7060X4 Series 100/200/400G Data Center Switches

The Arista 7060X4 series deliver high density 400G switching with line rate performance, proven layer 2 and layer 3 features, and advances in traffic awareness, congestion handling and instrumentation for

[Contact Us](#)



What Is an Aggregation Switch and How to Choose?

An aggregation switch is a network device that consolidates traffic from multiple access switches, wireless access points, or other edge devices and

[Contact Us](#)

Nokia S5AD400H Muxponder Card

Nokia S5AD400H Muxponder Card The high capacity, high performance Nokia S5AD400H muxponder provides an ideal solution for nx100G aggregation and 400GE transponder applications over metro,

[Contact Us](#)



AGR400

The AGR400 is engineered with the latest Broadcom StrataDNX(TM) Qumran2C silicon that targets use cases including OpenBNG, 100GbE aggregation router, PE

[Contact Us](#)



What Is an Aggregation Switch and How to Choose?

An aggregation switch is a network device that consolidates traffic from multiple access switches, wireless access points, or other edge devices and forwards it to

[Contact Us](#)



400G Solutions

For the most demanding environments the 400G routing and switching platforms provide flexibility and choice for large scale cloud, leaf and spine, routing

[Contact Us](#)

Iran Switch Co. , LinkedIn

Iran Switch Co. , ??? ?????? ??????? ?? ???????
Designing and manufacturing of low and medium voltage switchgear, switch, Medium Voltage Capacitor and Capacitor bank , We are pleased to introduce



[Contact Us](#)



Supermicro , Products , Networking , SSE-T7132

Supermicro's next generation 400Gbps Open Networking Switch SSE-T7132 is designed to provide high density and superior performance to meet the modern data datacenter demands.

[Contact Us](#)



Data Center Interconnect

Eliminate transponders with 400G-ZR optical modules 400G-ZR Modules integrate fully tunable, standards based, coherent DWDM optics directly into the switch or router, eliminating the need for

[Contact Us](#)



2. Imported design is convenient for expansion.

The design of two inlets saves space and allows for rear line entry.

V400 , Extreme Networks

EXOS Aggregation Switches The V400 operates in conjunction with 5420, 5520, X465, X590, X670-G2, and X690 Series switches which act as the "controlling" aggregation switch within the Extended

[Contact Us](#)

NVIDIA CONNECTX-7 , DATASHEET

ConnectX-7 400G Adapters Smart, Accelerated Networking for Modern Data Center Infrastructures The NVIDIA® ConnectX®-7 family of Remote Direct Memory Access (RDMA) network adapters supports

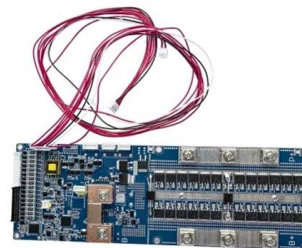

[Contact Us](#)

400G network aggregation for AI, core or edge computing , APCON

The IntellaView 400G EdgeSwitch performs aggregation, filtering, tunneling, Load Balancing, and more for high-demand AI applications and edge computing.

[Contact Us](#)





The gateway to more bandwidth with less fiber - optical

How transceiver aggregation and breakout work
First, pluggable transceivers are connected to a router or switch to send data streams over optical links. These

[Contact Us](#)

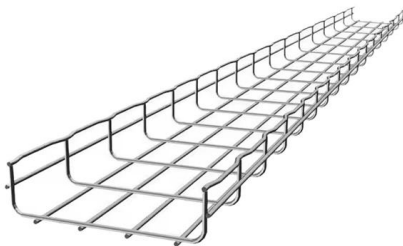

2.4T Aggregation Router

2.4T Aggregation Router The AGR400 is a high-performance 100GbE aggregation router featuring a fixed interface configuration of 2 x 400G QSFP-DD (21.3 W), 2 x 400G QSFP-DD (16.5 W), 4 x 100G

[Contact Us](#)

Contact Us

For datasheets, pricing, or custom fiber access solutions, please visit:
<https://frindel.es>