

Introduction to Aerial Optical Cable Junction Boxes

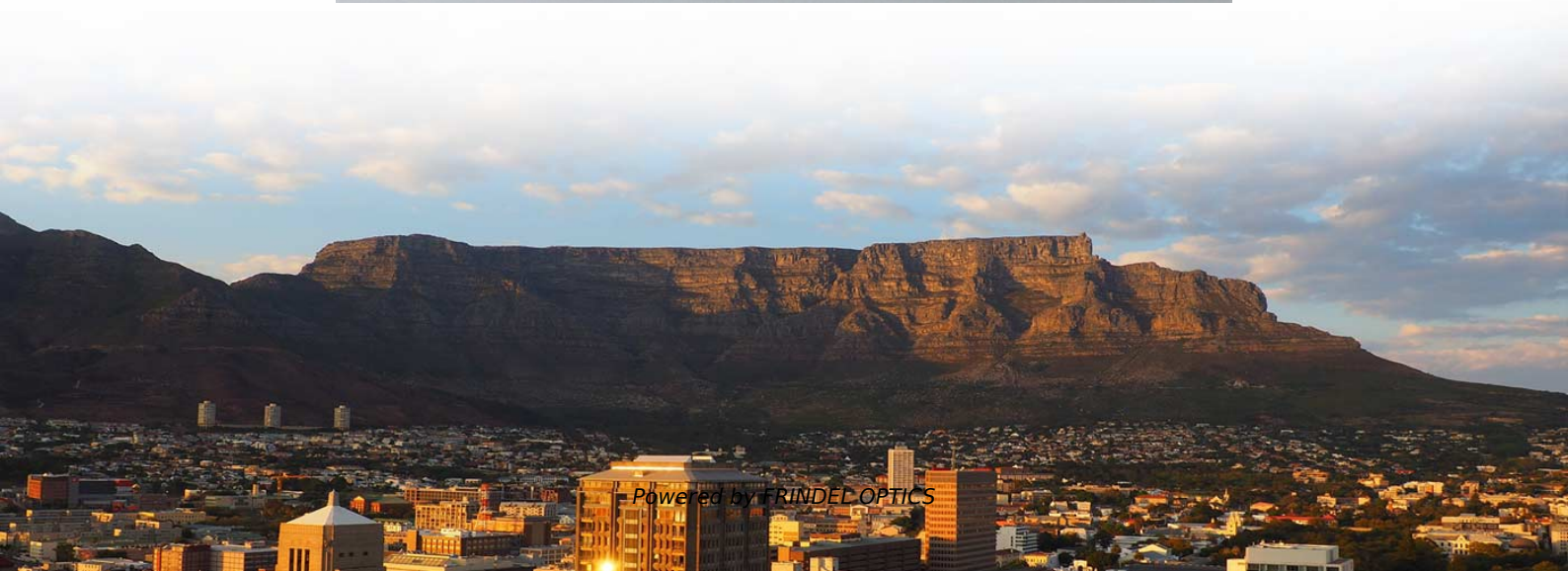

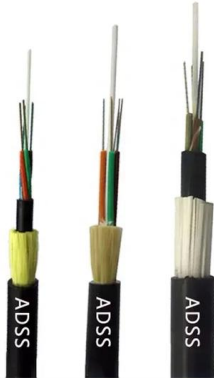

Introduction to Aerial Optical Cable Junction Boxes



All You Need To Know About Fiber Termination Boxes:

Source In this blog, we will discuss the two types of fiber optic cables and the role of a simple yet essential piece of equipment in the fiber laying

[Contact Us](#)

Aerial Fiber Optic Cable Overview and Installation Guide

The scene of aerial cables hanging in the pole is ubiquitous in our daily lives. Unlike other common fiber optic cables, this kind of optical cable is designed to adjust to the harsh outdoor



[Contact Us](#)



Metal Joint Junction Box, Splicing Box Manufacturer

ADSS/OPGW Metal Junction Box The ADSS/OPGW Metal Junction Box, also known as a splicing box or Metal Joint Junction Box, is designed to house fiber core

[Contact Us](#)

Fiber Optic Splice Enclosure, Fiber Optic Joint

Fiber splice enclosure box is used for aerial, strand-mount FTTH "tap" locations where drop cables are spliced to distribution cables. There are mainly two types

[Contact Us](#)



How to Choose the Right Optical Junction Box?

Optical junction boxes, also known as fiber splice boxes or fiber distribution boxes, serve as critical components in the optical fiber network. They accommodate and protect the fiber splices

[Contact Us](#)

Building outdoor fiber to home network, aerial fiber optic cable

In this video Building outdoor fiber to home network, aerial fiber optic cable deployment to last mile drop cable Jera Line Infrastructure 7.81K subscribers Subscribe



[Contact Us](#)

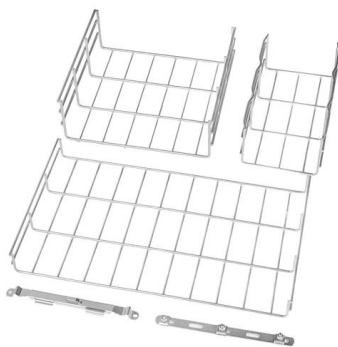

Intelligent Condition Monitoring Technology of OPGW Optical Cable

Keywords: Intelligent condition monitoring OPGW Cable junction box 1 Introduction Optical ber composite overhead ground wire is also called OPGW optical cable. It fi mainly refers to placing the

[Contact Us](#)



What is the Fiber Optic Junction Box?

The product adopts the two-time cabling technology to ensure that the optical fiber in the box has no additional decay. It has the multiple reuse and

[Contact Us](#)

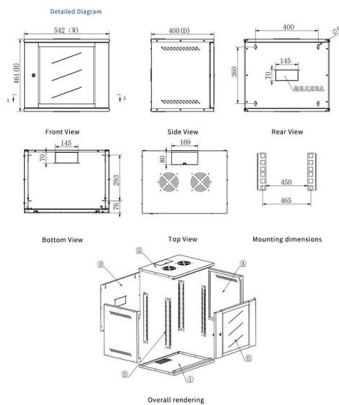

Fiber Optic Boxes

Fiber Optic Boxes The Fiber Optic Boxes are used to connect fibers in various FTTx network points. The outdoor fiber distribution boxes can be mounted on walls or

[Contact Us](#)

How Does an Optical Junction Box Work?

An optical junction box (OJB) is a crucial component in fiber optic networks, connecting various fiber strands and facilitating efficient data transmission. Understanding how it works is

[Contact Us](#)



Fiber Terminal Box VS. Junction Box: What is the

Imagine your fiber optic network as a high-speed information highway. Just like highways require exits, interchanges, and connections to reach homes

[Contact Us](#)





Microsoft PowerPoint

EWMJ joint boxes are specially designed to provide the maximum versatility for OPGW cable splicing, which enables their use in OPGW and other optical cable systems. The joint box is made of

[Contact Us](#)

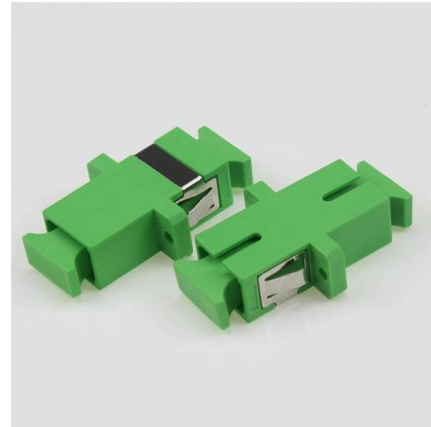

ADSS/OPGW Metal Junction Box

The ADSS/OPGW metal junction box is also called a splicing box that is designed to house the fiber core splices to the outdoor intermediate optical cable leading to

[Contact Us](#)

Aerial Fiber Optical Cable Engineering

It describes routing optical cables on poles, called aerial routing, and the engineering topology, procedure, and technical points for installing and protecting aerial

[Contact Us](#)



The Types of fiber Optical Terminal Boxes and How to

A box that comes with clear installation instructions and is easy to access for maintenance will save time and effort in the long run. By considering

[Contact Us](#)



Fiber Optic Junction Boxes

Glenair manufactures and supplies fiber optic junction boxes incorporating backshells, fiber media protection conduit, and electrical and optical connectors in both catalog and Mil-Spec variants.

[Contact Us](#)



An In-Depth Look at Junction Boxes - Cable Ties Unlimited

Introduction A junction box is a protective enclosure designed to safely house electrical wire connections. Its primary role is to prevent accidental contact with live wires, contain sparks or

[Contact Us](#)



FIBER OPTIC CONSTRUCTION STANDARDS

Fiber optic cable sequential numbers are required at each pole location and vault wall. Sequential numbers will identify conduit length, and slack left in vaults and at poles.

[Contact Us](#)



- IP65/IP55 OUTDOOR CABINET
- OUTDOOR MODULE CABINET
- OUTDOOR 5G BASE STATION CABINET
- WATERPROOF



Essential Guide to Optical Cable Junction Boxes: Key Benefits & FAQs

Optical cable junction boxes play a crucial role in managing and organizing fiber optic networks. These enclosures are essential for protecting fiber connections from environmental hazards and physical

[Contact Us](#)



Fiber Termination Boxes: A Beginner's Guide to

1. Introduction to Fiber Termination Boxes A Fiber Termination Box, also known as a Fiber Distribution Box, is a crucial component in fiber optic

[Contact Us](#)

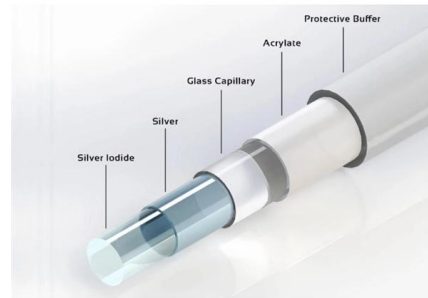

Optical Cable Junction Boxes: Functions and Features

Optical cable junction boxes are used in various communication paths, either wall mounted, aerial, in pipes or buried in the ground. In some

[Contact Us](#)

Aerial boxes

Our Aerial Enclosures are exclusively designed for Aerial Pole Mounting, Optical Splitting, Termination of Aerial Drop Cables and Branch Splicing of FTTH

[Contact Us](#)



Understanding Optical Fibre Junction Boxes: A Guide for Professionals

--- Optical Fibre Junction Boxes are critical components in the realm of telecommunications, serving as the interfacing point for optical networks. These junction boxes

[Contact Us](#)



Fiber-Optic Splice Boxes|Products|NITTO KOGYO

Fiber-Optic Splice Boxes Splice boxes keep joints of fiber-optic cables safe from external stress and manage excess cable lengths. They are also referred to as

[Contact Us](#)

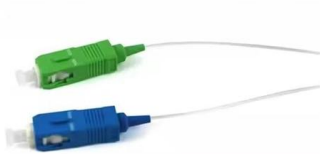

Which Fiber Optic Junction Box is Best?

When it comes to fiber optic junction boxes, a variety of options are available. Usually, a common question asked by customers is which box is best for their application.

[Contact Us](#)

Contact Us

For datasheets, pricing, or custom fiber access solutions, please visit:
<https://frindel.es>