

Instructions for Cold Aisle High-Temperature Resistant Installation of Edge Computing Cabinets

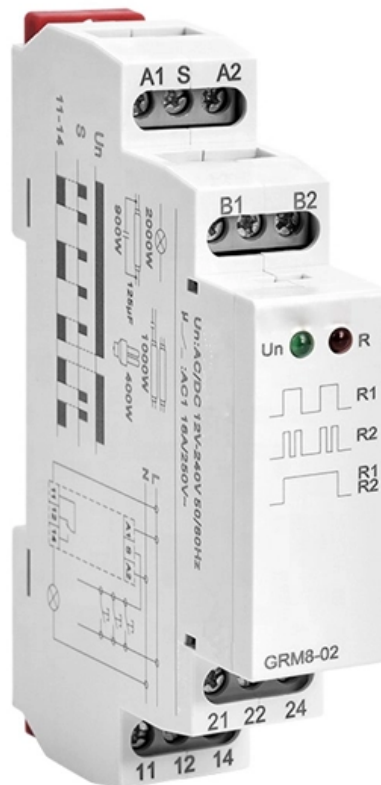



Instructions for Cold Aisle High-Temperature Resistant Installation



Vertiv(TM) Aisle Containment Syst

Working with your Vertiv partner, you just answer some simple questions about your application, such as the height of your tallest cabinet, aisle length and width, the type of roofing required and the

[Contact Us](#)

A DEEP DIVE INTO THE WORLD OF HOT & COLD AISLE

AISLE CONTAINMENT Aisle containment is a crucial strategy in data center management. It involves the use of physical barriers or enclosures at the end of server aisles to separate hot and cold

[Contact Us](#)

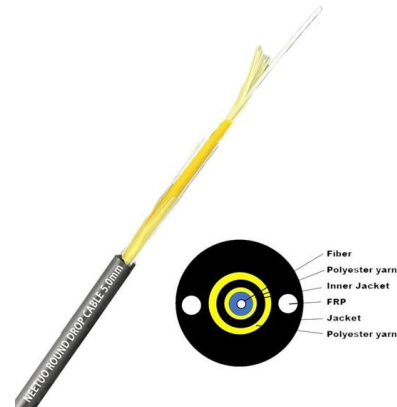

Optimizing Data Center Cooling: The Power Of Hot And

Discover how to optimize your data center cooling system with hot and cold aisle containment. Learn about the assessment, design, installation, and

[Contact Us](#)



Hot Aisle Containment System Installation

The Hot Aisle Containment System encloses a hot aisle to collect and cool equipment exhaust, making it available for cool air intakes. This creates a self-contained system capable of supporting high density

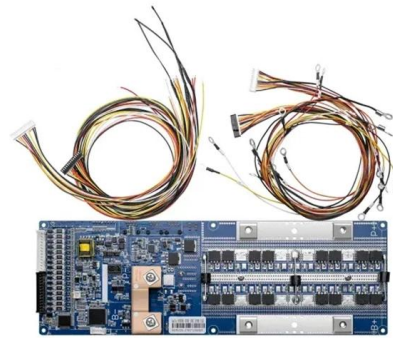

Hot/Cold Aisle Containment

Hot/Cold Aisle Containment In a typical Data Center, only 30% of the conditioned air gets to where it's needed, resulting in as much as two and a half times more cooling than necessary. Using

[Contact Us](#)

Numerical analysis of the individual and combined effects of the aisle

This study underscores the necessity of high-fidelity CFD modeling for accurate airflow diagnosis and offers practical design guidelines for developing reliable and thermally efficient edge



[Contact Us](#)



CONTAINMENT SYSTEM

High energy costs and accelerated energy consumption has forced data center managers to implement strategies to achieve separation between the hot and cold air in the data center.

[Contact Us](#)



Hot/Cold Aisle Containment

Want to stop even more chilled air from escaping? GapHOG™ products keep chilled air from escaping into odd spots where it is not used; such as above, below and in-between data center hardware or

[Contact Us](#)



Hot/Cold Aisle Containment , Data Center Containment

An aisle containment system is a simple way to improve cooling efficiency in hot aisle/cold aisle rack configurations. Essentially creating a room within the aisle,

[Contact Us](#)

Cold Aisle Containment in Data Centers , Subzero

Minimize your data center's footprint, establish optimal operating efficiencies and save money with cold aisle containment. Learn more here!

[Contact Us](#)



FOCUSED COOLING USING COLD AISLE CONTAINMENT

As an addition to a conventional precision cooling system, cold aisle containment consistently separates cold and warm areas without requiring structural changes to the data center.

[Contact Us](#)

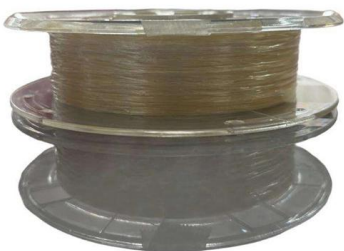



Aisle Containment Systems Physical Containment Systems

Hot aisle/cold aisle configuration is a best practice solution that separates hot and cold air streams. This method raises the temperature of the air returning to a Computer Room Air Conditioner (CRAC) unit,

[Contact Us](#)



Aisle Containment Systems Physical Containment Systems

Retractable System: The Easy-To-Install Containment Solution The Retractable System exclusively for a 4' or 6' aisle ceiling, is a truly unique and easily deployed solution.

[Contact Us](#)

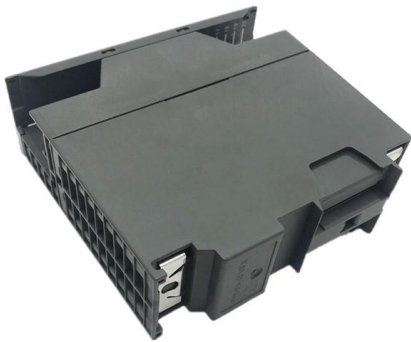

Vertiv(TM) Aisle Containment Syst

Adaptable to hot and cold aisle containment, the Vertiv Aisle Containment System allows you to deploy containment before racks are installed to simplify installation and speed deployment of new data

[Contact Us](#)



Hot Aisle Containment (HAC) for Data Centers Explained

Looking for a way to reduce energy expenses for your data center? According to Energy Star, data centers with hot/cold aisle arrangements can

[Contact Us](#)



FAMILY BROCHURE Aisle Containment



Solutions

Elevate cold aisle solutions are specifically engineered to support raised floor cooling systems, ensuring optimal airflow and temperature regulation within your data centre.

[Contact Us](#)

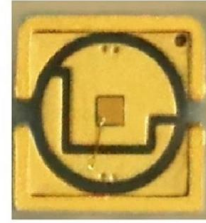

Hot and cold aisle cooling containment

More frequently, data centers are using hot and/or cold aisle cooling containment solutions to help with managing airflow, eliminating hot spots and improving energy efficiency. In most cases, the rack

[Contact Us](#)

Cold Aisle Containment

Product Description Aisle containment in the data center requires that cabinets are aligned in a hot aisle/cold aisle layout. Containment panels or strips create a

[Contact Us](#)

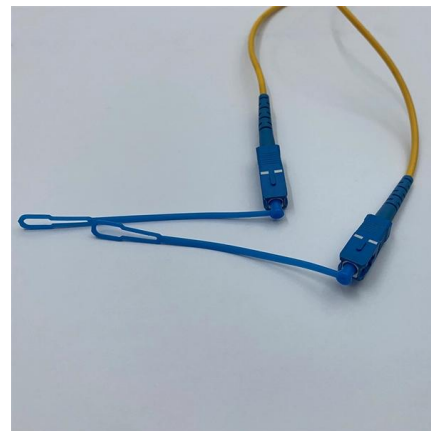

Cold Aisle Containment , Legrand

By maintaining consistent, predictable temperatures, cold aisle containment minimizes thermal stress and reduces the risk of overheating, improving reliability and extending equipment lifespans.

[Contact Us](#)



Hot Aisle Containment: The Coolest Guide for

Hot aisle containment data centers are engineered to optimize cooling efficiency and minimize energy use by effectively

[Contact Us](#)

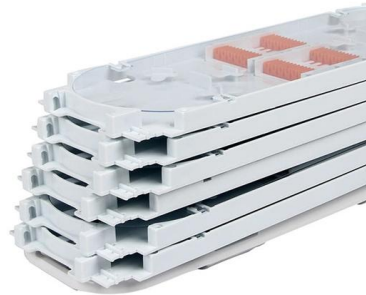

Vertiv Aisle Containment System

The Vertiv™ Aisle Containment System simplifies aisle containment in data centers both large and small. With the flexibility to quickly and easily configure and assemble a solution for your current and

[Contact Us](#)

Net-Contain and Net-Direct Thermal Management Solution

Retrofitting the Universal Aisle Containment System into your existing data center allows you to optimize the separation of hot and cold air, enabling higher per cabinet density, reclaiming 10% of existing

[Contact Us](#)



Cold Aisle Containment

Retrofitting Cold Aisle Containment System From EDP Europe EDP provides custom Cold Aisle Containment solutions for existing data centres. These solutions are

[Contact Us](#)



Hot vs Cold Aisle Containment: 40% Cooling Savings

If data centers were action movies, hot and cold aisle containment would be the unsung heroes, saving the day without getting the glory. While

[Contact Us](#)

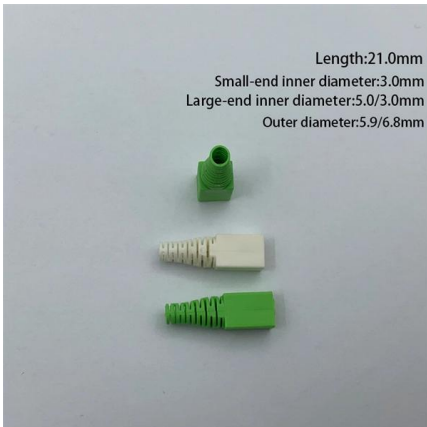
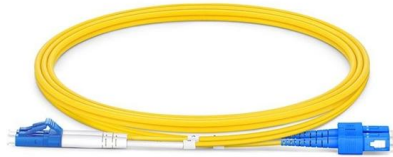

Vertiv SmartAisle Containment

Vertiv designs, builds and services mission critical technologies that enable the vital applications for data centers, communication networks, and commercial and industrial environments. We support

[Contact Us](#)

CONTAINMENT SYSTEM

Cold Aisle drop away ceiling panels (clear or opaque) Class A rated, CA State Fire Marshal, UL & FM Global listed and approved Hot aisle to plenum light-weight cabinet supported vertical panels speed

[Contact Us](#)

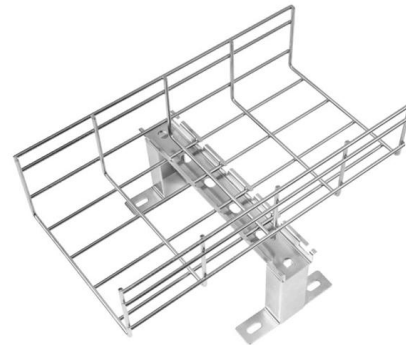

Aisle Containment Systems for Hot & Cold Aisle Solutions

Cool Shield Aisle containment solutions reduces server row temperatures in active data centers. Learn more about the benefits of hot and cold containment.

[Contact Us](#)



Hot Aisle Containment in Data Centers , Subzero

Hot aisle containment through raised flooring, vinyl strip doors, and vinyl Rack Hat of varying height to provide containment in gaps between ceiling, cabinets, and

[Contact Us](#)

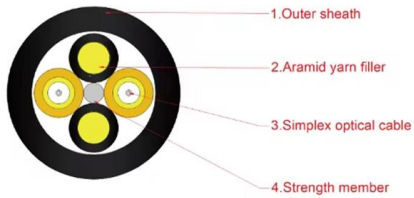

Hot and Cold Aisle Containment Solution , Legrand

Effective aisle containment is critical to maintaining peak data center cooling efficiency. By creating a physical barrier between cold supply air and hot exhaust

[Contact Us](#)

Cold Aisle Containment Systems , Server Room Environments

For retrofit sites, cold aisle containment can be easier to install than hot aisles. Provided the site has an underfloor or overhead cool air supply. The most common approach is to use clear ceiling panels

[Contact Us](#)



Contact Us

For datasheets, pricing, or custom fiber access solutions, please visit:
<https://frindel.es>