

Indicator lights for construction site power distribution boxes





Indicator lights for construction site power distribution boxes



Indicator Lights , Visual Status Signals For Panels , CEF

Available in various colours, voltages, and mounting styles, these lights alert users to power presence, faults, or operational states. They are widely used in commercial and industrial environments to

[Contact Us](#)

Control switches, pushbuttons and indicator lights

The use of switches, pushbuttons and indicator lights enables switching, controlling and electrical consumer indications from a central point.

[Contact Us](#)

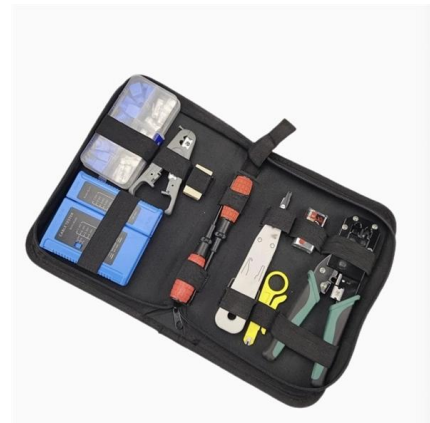

Summary of key points for construction and installation of distribution

The construction and installation points of distribution boxes and switch boxes are summarized as follows: 1. Select qualified products that meet national standards and safety requirements.

[Contact Us](#)

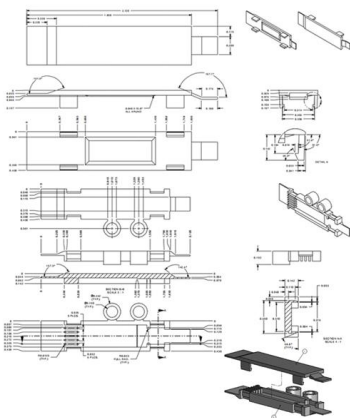

Temporary Jobsite Power Setup: NEC & OSHA Compliance Guide

Ensure NEC & OSHA compliance with your temporary jobsite power setup using a reliable industrial portable power station.

[Contact Us](#)



Portable Power Distribution

Power Your Projects with WorkSite Lighting's Portable Power Distribution Solutions. When your job demands reliable, portable power, WorkSite Lighting delivers. We

[Contact Us](#)



Power supply on the construction site

Mounted as crane lighting, this high-performance LED spotlight provides excellent illumination for your construction site. In combination with our modular bracket, you remain flexible, as the different

[Contact Us](#)



Expert Guide: Select the Right Temporary Power Distribution Box

Expert Guide: Select the Right Temporary Power Distribution Box Workplace injuries from slips, trips, and falls make up 27% of all incidents, and messy wiring is often the culprit. Temporary power

[Contact Us](#)





Paneltronics: Led Indicators for Circuits

Indicator Lights for electrical panels and power distribution units.

[Contact Us](#)

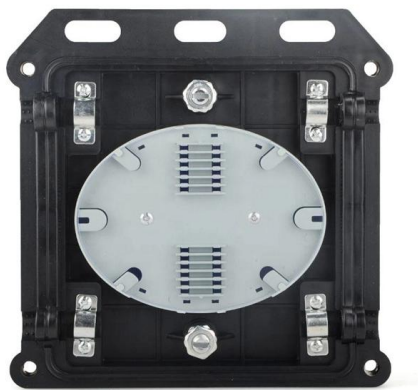

Safety requirements of distribution box

The power distribution and lighting distribution of construction electricity should be set in separate boxes. When they are combined in the same box, the power and

[Contact Us](#)

Electrical Site Plan Symbols

Symbols related to power distribution are among the most frequently encountered on electrical site plans. These graphically represent the locations

[Contact Us](#)



Top Necessities For Proper Construction Site Power

Temporary power distribution is common place on most construction sites, driven by the need to supply convenient portable power access for a wide

[Contact Us](#)



Temporary Power Construction Site Guide: Industrial Plug Sockets,

Discover how to supply temporary power safely on construction sites using E-abel distribution boxes, industrial plug sockets, and IP67 connectors for reliable outdoor electricity.

[Contact Us](#)

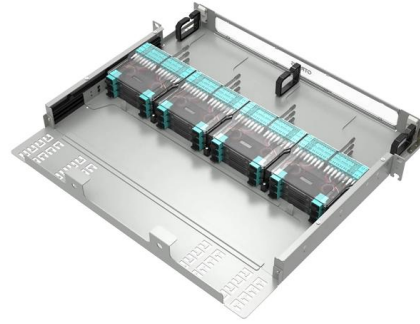

The Ultimate Guide to Temporary Power Distribution Boxes

On construction sites, temporary power distribution boxes are essential for providing power to tools, machinery, and temporary lighting. This

[Contact Us](#)

ENERGY METALBOX Assemblies for Construction

ENERGY METALBOX range consists of construction site distribution boards in metal cabinets with technopolymer socket-outlets. The steel sheet enclosure is fitted

[Contact Us](#)



Temporary Power Safety: Distribution Boxes + Industrial

Learn how construction power, temporary electrical boxes, and IP67 connectors combine with E-abel distribution panels and Weipu industrial

[Contact Us](#)



Signal Indicator Lights in Power Distribution Systems: Key Uses

Signal indicator lights are visual devices installed in electrical panels, switchgear, and distribution boards. They indicate the presence of voltage, system status, and fault conditions

[Contact Us](#)



How To Maximize Worksite Safety When Using Power Distribution Boxes

Temporary power distribution is an essential but potentially dangerous aspect of most jobs. Temporary electrical power is utilized in many places like construction sites, plants, and

[Contact Us](#)

Industrial Construction Site Power Distribution Boxes

Industrial Construction Site Power Distribution Boxes Electrical Enclosure, Find Details and Price about Boxes Electrical Enclosure Distribution Boxes Electrical

[Contact Us](#)

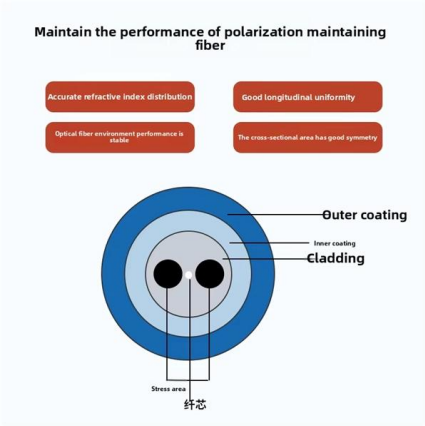

Everything You Need to Know About Temporary Power

We pride ourselves on offering customizable, industry-leading products and unparalleled sales support. Our portable construction boxes have

[Contact Us](#)



How to Make Temporary Power Safer on Construction

Learn how E-abel temporary power cabinets and industrial waterproof plug systems improve construction site electricity safety, reduce wiring errors,

[Contact Us](#)

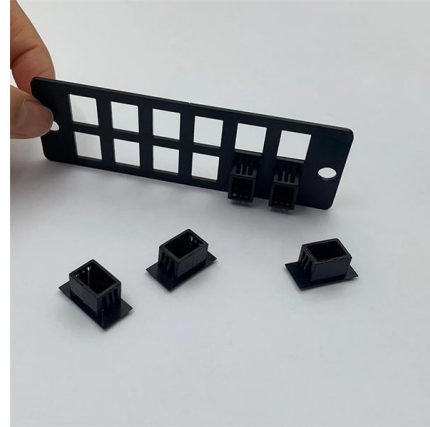

Construction site

PCE power distribution units are valuable helpers for construction, trade and industry. All devices are subjected to strict quality control and are designed to be extremely user-friendly.

[Contact Us](#)



Panel Mount Indicators , Panel Mount LED Light Indicators , RS

Multi-color panel mount LED indicators are especially useful for showing multiple machine states in one location. Power and fault indication: Provide quick visual checks for power presence, breaker/trip

[Contact Us](#)



Temporary Power Distribution and Industrial Lighting

Get reliable temporary power distribution and construction lighting solutions for your worksite needs with our portable power boxes, panels, and LED work lights.

[Contact Us](#)





High-Quality Electrical Lighting Distribution Boxes Explained

Electrical lighting distribution boxes play a crucial role in managing and distributing power for various lighting systems. These versatile components are essential for ensuring safe and efficient operation



[Contact Us](#)



Understanding Fault Indicators: A Key Tool in Electrical

Discover the crucial role of fault indicators in maintaining electrical system reliability. Learn about their types, working mechanisms, and benefits to

[Contact Us](#)

Construction , Trystar

Trystar is your trusted partner for all your construction power needs. From temporary power distribution to custom power solutions, we have you covered!



[Contact Us](#)

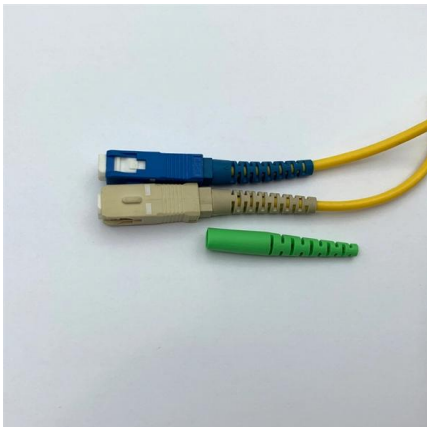

Construction site power distributors

The portfolio includes matching standard products for various specific applications, such as containers, lighting and cranes. For connection distributors, suitable solutions are available ex stock for rapid

[Contact Us](#)



Power and energy distributors , Elektron Berlin

Power distributor - Energy distributor on construction sites ELKRAFT® stands for power distributors - power distributors on construction sites. More than 100 years

[Contact Us](#)

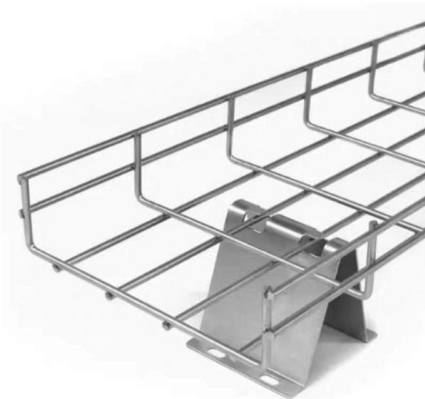
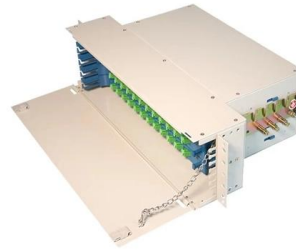

ENERGYBOX Assemblies for Construction Sites (ACS)

ENERGYBOX is a complete range of Assemblies for Construction Sites (ACS) pre-wired boards that can be wall-mounted or installed on a support.

[Contact Us](#)

Contact Us

For datasheets, pricing, or custom fiber access solutions, please visit:
<https://frindel.es>