

Hungarian 19-inch rack-mount chassis

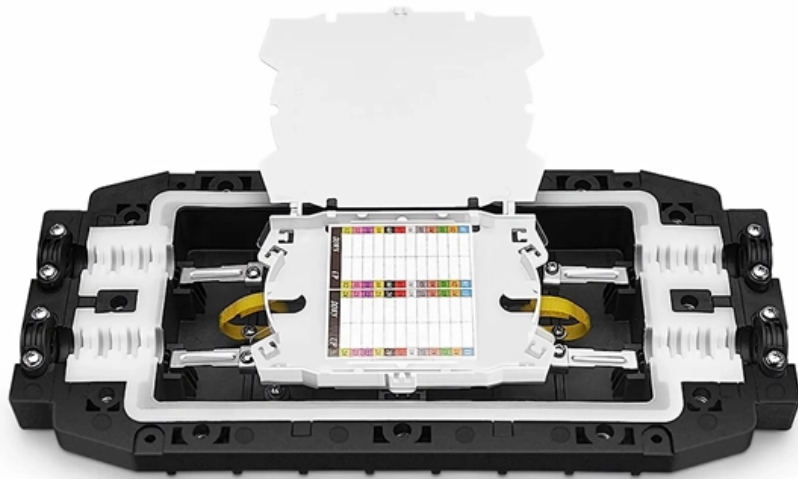



Hungarian 19-inch rack-mount chassis

19-inch 1U rack-mount server chassis



1U rack-mountable server-chassis for 19-inch racks and cabinets. Find a large variety at yakkaroo Serversysteme.

[Contact Us](#)

19-Inch Rack Size and Dimensions Explained: The Complete Guide to

Discover the essential guide to 19-inch rack sizes and dimensions for servers and rackmount PCs. Learn about standards, specifications, and best practices today!

[Contact Us](#)



19" RACK MOUNT ENCLOSURES?19 INCH RACK

19 inch rack mount cases in 1U, 2U, 3U, 4U, and 5U heights for mounting directly onto 19" racks and cabinets. Customization of enclosures and 19 inch panels are

[Contact Us](#)

19" chassis

The TPS 2U Chassis (BJ9900002) is a standard 19-inch rack-mount power supply chassis for industrial use, suitable for servers, telecom systems and data centers.

[Contact Us](#)



19" Rack PCs , InoNet

These enclosures are often used in rack mounting, e.g. in data centres, to mount several computers or servers in a space-saving manner. Our 19-inch industrial PCs fulfil the standardised width of 19

[Contact Us](#)



19 Inch Rack , Industrial Computer and Components from ICP IEI

19-inch rack enclosures provide a standardized way to securely mount and manage electronic components. With a width of 19 inches (approx. 482.6 mm) and standardized height units (U), they

[Contact Us](#)



Interscale 19" Rack Mount Chassis, Non-Perforated, 2 U, 84 HP, 310 mm

Flexible 19" Chassis with integrated EMC protection. Based on the nVent SCHROFF Interscale platform and developed in accordance with IEC 60297-3-109.

[Contact Us](#)





19" Chassis Options , CP Cases US

The Facts Increase the payload capacity of your electronic racks with robust aluminium chassis engineered for maximum durability. EasyGlide chassis options

[Contact Us](#)



Rack unit

A rack unit (abbreviated U or RU) is a unit of measure defined as inches (44.45 mm). It is most frequently used as a measurement of the overall height of 19-inch

[Contact Us](#)

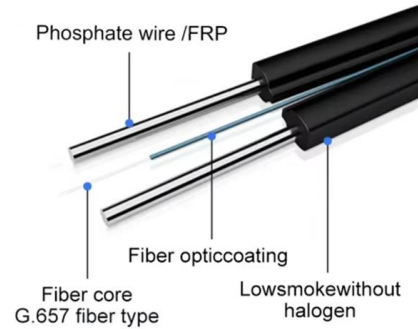

Atlas Chassis

Atlas Chassis DIMENSIONAL CHARACTERISTICS
Heights: 2U to 6U (or more depending on front)
Width: 19" (chassis width 429 ext.) Depths: 360 / 460 mm

[Contact Us](#)



19" RACK MOUNT ENCLOSURE

19" RACK MOUNT ENCLOSURE - AUXR series
AUXR Series -PDF CATEGORY:Aluminum enclosure,19" rack mount enclosure, 19 inch rack case,

[Contact Us](#)



19-inch 2U rack-mount server chassis

2U rack-mountable server-chassis for 19-inch racks and cabinets. Find a large variety at yakkaroo Serversysteme.

[Contact Us](#)



19" Rackmount Chassis for VPX, VME , Elma Electronic

Powerful 19" rack-mount chassis platforms from commercial grade to full MIL-STD for a wide range of integrated rack-mount applications.

[Contact Us](#)

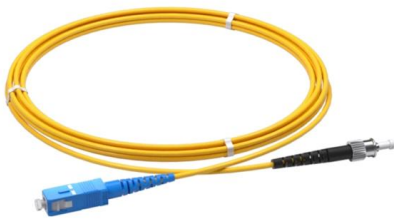

19? Rackmount Chassis - Glaum Enclosures Pvt. Ltd.

19? Rackmount Chassis Home 19? Rackmount Chassis Photos Technical Specifications Related Products Seek a Quote Request Detailed Catalogue DIS -

[Contact Us](#)

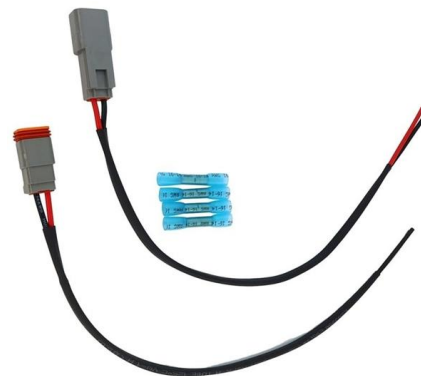

Home

Heavy-Duty Rack-Mount Chassis Our Heavy-Duty Rack-Mount Chassis assemble with stainless steel machine screws, lock washers, and captive PEM nuts which

[Contact Us](#)





Server case rackmount chassis 19 inch IPC ATX 4U

Chassis box for mounting a CPU in a rack 19 "cabinet. Specially designed housing for the installation of computer equipment of intensive use such as servers,

[Contact Us](#)



19 Inch Enclosure

Mainly sell Rack Mount PC Case, Aluminum Chassis, waterproof enclosure and so on. Our 19 Inch Enclosure can be customized in various dimensions, height

[Contact Us](#)



Powerful manufacturers - 20+ years of experience - Support customization

For more product types, please contact customer service>>>

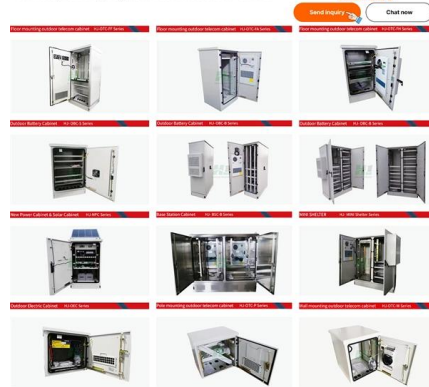

19" rack chassis , Newegg

4U all-in-one machine / 19-inch rack-mounted industrial control chassis / supports standard industrial backplane or industrial motherboards of 12 x 9.6 inches and below / empty chassis.

[Contact Us](#)



19 Inch Rack Mount Enclosures , Metcase USA

Modern and versatile 19 inch rack mount enclosures in standard 1U, 2U, 3U, 4U, 5U and 6U sizes. Custom versions made to order. View range

[Contact Us](#)



19 Inch Rack Mount Din Rail Chassis Panel (4U/5U)

Compact and durable 19 inch rack mount DIN rail chassis Panel for organized installation of DINrail devices in data centers and industrial enclosures.

[Contact Us](#)

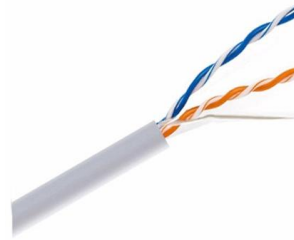

Custom Integrated 19" Racks Solutions , Elma Electronic

Integrated 19 in racks are complete rack systems that house electronics, power, cooling, and mechanical interfaces in a standardized 19-inch format -- providing a pre-engineered platform for

[Contact Us](#)

Techrack , Build Your Own Server Rack , 19 inch Rack Mounts

This modular approach to server rack cabinets allows you to create the perfect cabinet required for your growing data center. Select the the specific FRAME and then add the components you



[Contact Us](#)



19" Chassis Options , CP Cases UK

Our custom 19" chassis options make your electronic racks work for your unique needs, adding extra strength and practicality.

[Contact Us](#)



19 inch subracks and chassis

19" subracks are used for housing plug-in circuit boards (e.g., 3U, 6U, 84HP) according to IEC 60297 and IEEE 1101.x. The construction is done using carrier

[Contact Us](#)



The Complete Guide to 19-Inch Industrial Chassis: Custom Enclosures for

This guide gives you a clear, practical overview of 19-inch industrial chassis design, the differences between steel and

[Contact Us](#)

19 inch racks

Our onlineshop contains a broad variety of 19-inch rack mount chassis types from 1U to 4U.

[Contact Us](#)

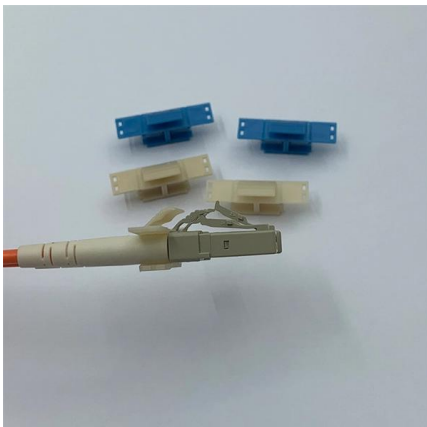

Atlas Chassis

19" Chassis provided for the integration of non-standardised elements (coils, power supplies, measurement enclosures, etc.). Product that can withstand large loads.

[Contact Us](#)



Contact Us

For datasheets, pricing, or custom fiber access solutions, please visit:
<https://frindel.es>