

# How to Choose Galvanized Cable Trays from Finland





## How to Choose Galvanized Cable Trays from Finland

---



### How to Choose the Right Cable Tray for Your Project?

Learn how to select the best cable tray for your project with insights on load capacity, corrosion resistance, customization, and common applications.

[Contact Us](#)

### Galvanized Steel Cable Trays vs. Stainless Steel: which

Cable trays are essential elements in the cabling infrastructure of any building or industrial facility to ensure the support and protection of the cabling.

[Contact Us](#)

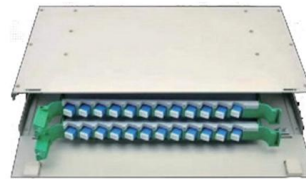

### SS Cable Tray VS Galv Cable Tray: Which One Is Right

Explore the differences between SS Cable Tray VS Galv Cable Tray, comparing material, corrosion resistance, cost, weight, and applications. Find out

[Contact Us](#)

### The Professional Buyer's Guide to Selecting Galvanized

Maximize durability and safety with our professional buyer's guide. Learn how to select the right galvanized cable trays for industrial environments,



### **Cable Tray Fire Safety Tips for Commercial Buildings**

Discover the best cable tray fire safety practices for commercial buildings to improve electrical safety and reduce fire risks.

[Contact Us](#)



### **How To Choose Right Galvanized Cable Tray?**

Learn the main types of galvanized cable trays, including HDG cable tray, GI cable tray and Pre-galvanized cable tray with JLH Electric.

[Contact Us](#)



### **Cable Tray Manufacturers in Dubai, Abu Dhabi, Sharjah,**

Unigroup supplies perforated, ladder, and galvanized cable trays in Dubai, Abu Dhabi, and Sharjah with full support systems and installation accessories.

[Contact Us](#)





## How to Choose Galvanized Cable Tray You need to know

Learn how to choose the right galvanized cable tray for safe, efficient cable management: compliance, load capacity, and installation tips.

[Contact Us](#)



### MORE CASES PRESENTATIONS



## Cable trays , Ahlsell - We make it easier to be professional

Sendzimir galvanized cable ladder with perforated rungs. Pin distance: c-c 250 mm. Criminal load: more than or equal to 1.7 times the maximum load.

[Contact Us](#)

## How to Choose a Cable Tray for Your Needs: A

You can use cable trays to do so. These trays primarily perform two functions in a building: cable management and wire protection. However, with so

[Contact Us](#)



### High Quality Aluminum Housing with Compact Size

- Sturdy and Durable
- Anti-corrosion

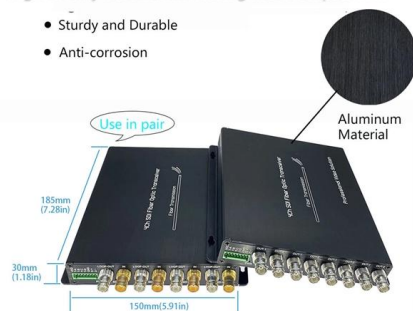

## Cable Tray Size Chart and Selection Guide

Cable tray depth directly impacts both cable capacity and installation practicality. Deeper electrical cable tray dimensions provide greater sidewall containment, preventing cables from spilling

[Contact Us](#)



## Ultimate Guide to Cable Tray Selection - Types,

Selecting the right cable tray is essential for safety, efficiency, and compliance with industry standards. This guide will help you choose the best

[Contact Us](#)



## How to Choose the Right Steel Cable Tray for Your IT

Steel cable trays are essential in organizing & protecting electrical & IT cables. This guide helps you choose the right tray for your needs.

[Contact Us](#)

## Cable Trays & Accessories , Cable Management Systems , MEP

SFSP manufactures a wide range of products capable of providing the characteristics which respond to the proposed application, along with quality of assembly, speed of installation, and cost-saving cable

[Contact Us](#)

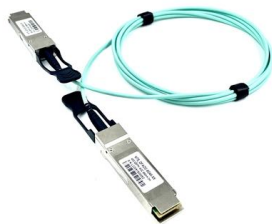

## Verified Supplier Cable Tray 400mm Hot-Dipped Galvanized Material

Shop high-quality cable tray 400mm from reliable suppliers. Durable, galvanized, and perfect for indoor and outdoor electrical systems. Bulk orders available.

[Contact Us](#)



### Hot-Dipped Galvanized Ladder Tray

Rigid, hot-dip galvanized Cope cable trays ensure safe, easy installation and meet NEMA VE-1 standards.

[Contact Us](#)

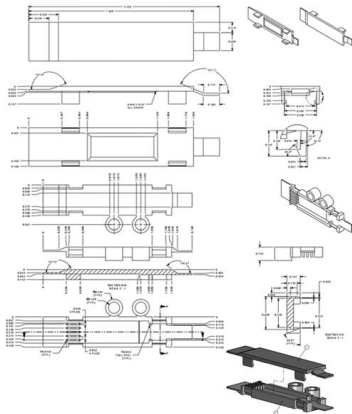
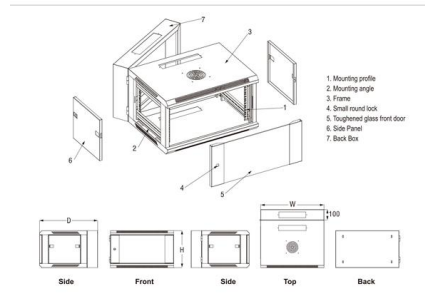

### AshwinD24's gists · GitHub

GitHub Gist: star and fork AshwinD24's gists by creating an account on GitHub.

[Contact Us](#)

### Eurostrut Cable Trays , cable tray, cable route and

Cable trays for industrial and marine use. Includes distribution trays, cable routes and NATO-type models. Request a quote directly via our webshop.

[Contact Us](#)



### Galvanized Cable Tray Manufacturing in Kenya

Galvanized cable tray systems support reliable electrical installations across Kenya's growing infrastructure projects. Contractors choose galvanized cable tray products for durability and corrosion

[Contact Us](#)



## A Guide to Cable Tray Accessories and Their Functions

Explore a detailed guide to cable tray accessories and understand their uses in ensuring safety, stability, and efficiency in electrical system

[Contact Us](#)

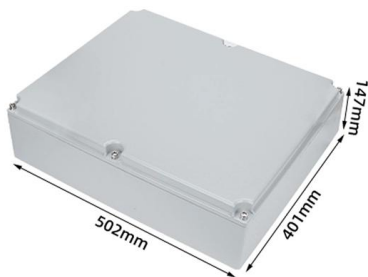

### Cable trays

We offer a wide range of cable tray systems to support tubing, electrical cables and instrumentation. Our cable trays are produced in fit for purpose materials like

[Contact Us](#)

### The Ultimate Guide to Selecting High Quality

Choosing the right tray system is more than just about immediate needs; it is a commitment to a sustainable, safe, and efficient electrical infrastructure. Once

[Contact Us](#)

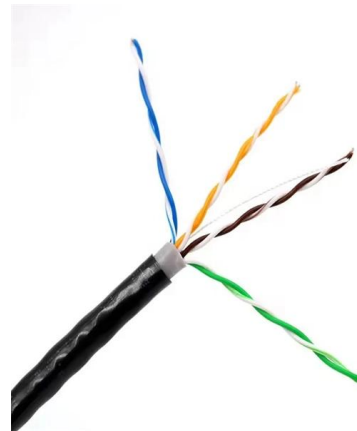

### Cable Trays

Cable Trays Cable tray is a system used to safely carry and protect electrical cables along pathways planned specifically for building and facility installations.

[Contact Us](#)



### Galvanized Cable Tray In Finland



What are Galvanized Cable Trays? They are a type of cable support system manufactured from steel sheets coated with a zinc layer through a hot-dip galvanization process. This zinc coating provides

[Contact Us](#)



## Contact Us

---

For datasheets, pricing, or custom fiber access solutions, please visit:  
<https://frindel.es>