

# **High-pressure heat-resistant galvanized cable trays**

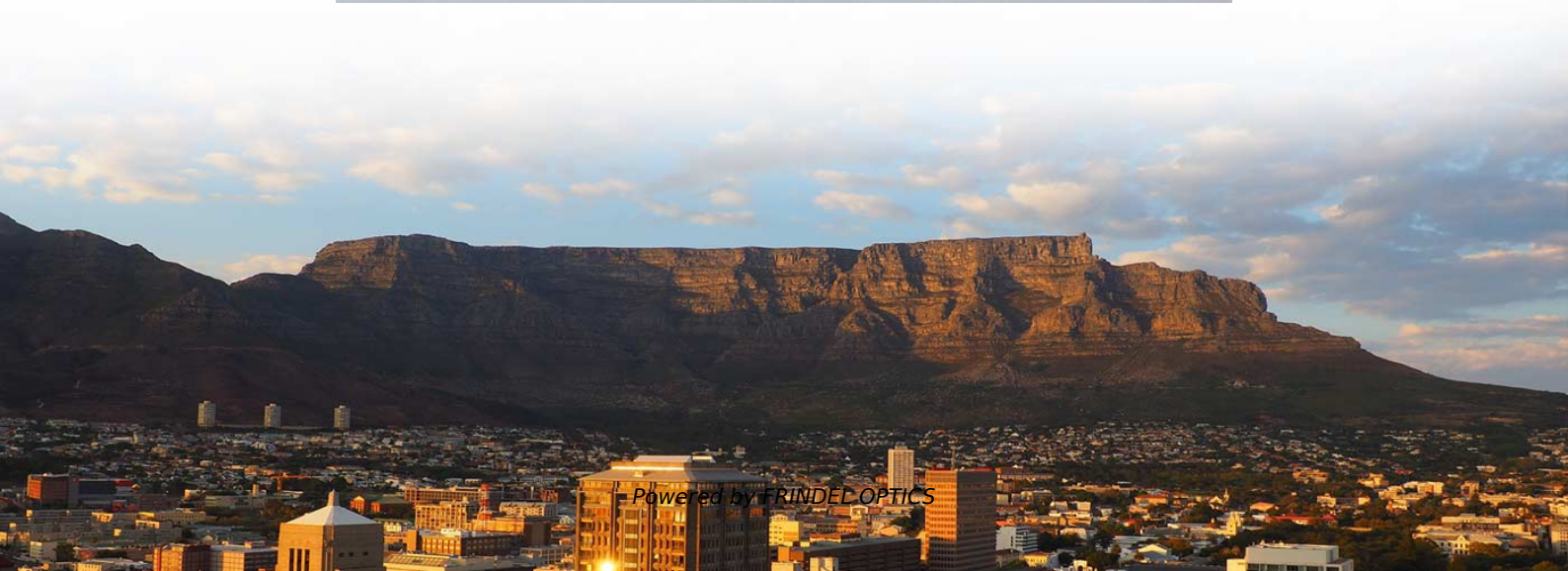



## Overview

---

The full-shaped HDG trays are dipped into a large bath of hot, liquid zinc. It is this heavy shield that makes the metal resistant to rain and salt air for over 20. PFLITSCH has the perfect solution for requirements like these: our non-enclosed Wire-tray Trunking combines many different advantages and is convincing in every respect. Strong and durable – Made of hot-dip galvanized steel or stainless steel, suitable for indoor and outdoor applications. It offers true freedom by allowing multiple configurations in a wide choice of finishes for optimal integration into any environment.



## High-pressure heat-resistant galvanized cable trays

---



### Cable Tray Technical Guide A practical guide to product selection and

**SOLID-BOTTOM CABLE TRAY** Providing additional cable protection, solid-bottom cable tray is sometimes preferred to support and protect numerous small instrumentation and control cables.

[Contact Us](#)



### CABLE TRAYS

This white paper compares the High Resistance (HR) and Hot-Dip Galvanising (HDG) solutions and highlights the new High Resistance range, ZnAl wiremesh, ZnMg metal cable trays and accessories

### Wire Mesh Cable Tray Solutions o PFLITSCH

Thanks to its non-enclosed design and the use of corrosion-resistant steel or stainless steel wire, which is additionally resistant to all common cleaning agents, our Wire-tray Trunking can be cleaned easily

[Contact Us](#)



### Artim Metal, Metal Cable Trays, Cable Tray,

**40 Series Perforated hot-dip** is a high capacity cable transportation system resistant to harsh outdoor conditions. Hot-dip galvanized coating provides excellent

[Contact Us](#)



### Galvanized Cable Trays: Durable & Corrosion-Resistant Solutions

Discover galvanized cable trays for industrial and outdoor use. Ideal for corrosion resistance, heavy-duty support, and long-term durability. Click to explore top-rated suppliers and

[Contact Us](#)



### Hot Dip Galvanized Cable Tray Manufacturers , HDG GI

Durable Hot Dip Galvanized (HDG) cable trays designed for superior corrosion resistance, strength, and reliable cable management in industrial and outdoor

[Contact Us](#)



### Galvanized Cable Tray, Perforated Cable Tray Manufacturer

The materials used in these trays can withstand heat and electrical stress, which is crucial in high-risk environments. Our galvanized cable trays have a professional appearance due to their smooth

[Contact Us](#)





## Hot-dip galvanized steel cable trays , Technical guide for demanding

Detail of hot-dip galvanized steel cable trays installed in a demanding industrial environment. Learn when to choose hot-dip galvanized steel cable trays according to EN ISO 1461:

[Contact Us](#)

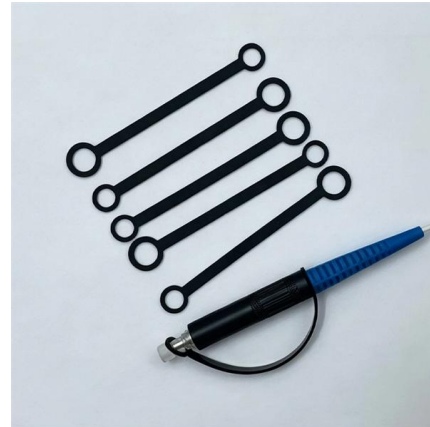

### Mesh door/glass door optional



Sp-601 glass door

Sp-602 mesh door

## GI Cable Tray Manufacturers , Hot Dip Galvanized Iron

Manufactured from galvanized iron, these trays are highly resistant to rust and

[Contact Us](#)

## Artim Metal, Metal Cable Trays, Cable Tray, Manufacturer

Thanks to the hot-dip galvanizing process, it has high resistance to corrosion and is resistant to severe weather conditions. Its perforated structure optimizes air and heat transfer while offering an aesthetic

[Contact Us](#)

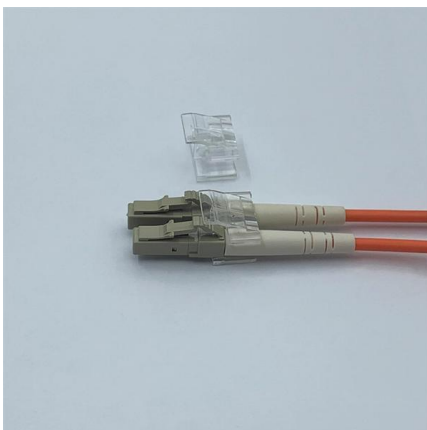
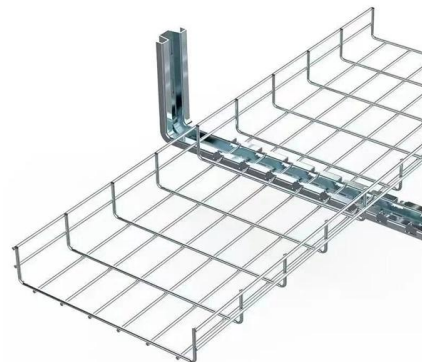

## HDG Perforated Cable Tray , GI Cable Tray

As a top gi cable tray manufacturer, Parco Engineers delivers high-grade galvanized perforated cable trays that conform to industrial standards of safety, performance,

[Contact Us](#)



## Comprehensive Guide to Hot-Dip Galvanize Cable Trays

Learn about the hot-dip galvanize cable trays process, benefits, and key considerations. Discover how this corrosion-resistant treatment enhances the

[Contact Us](#)

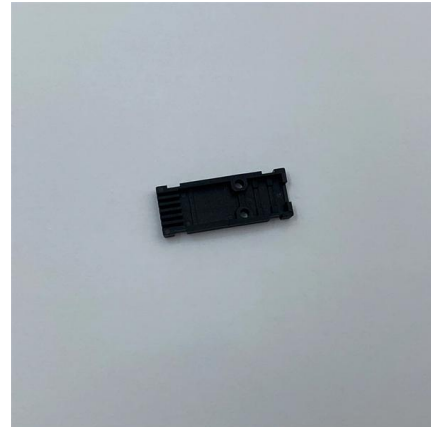

## Cable Trays

Perforated cable trays with covers are suitable for supporting high voltage (ranging from 1.5kv - 35kv) cables such as power cables, controlling cables in power

[Contact Us](#)

## Hot Dip Galvanized Cable Trays

HOT DIP GALVANIZED CABLE TRAY Our Hot Dip Galvanized Cable Trays are used extensively in Buildings, Water Power Industrial Sectors, Malls, Railway

[Contact Us](#)

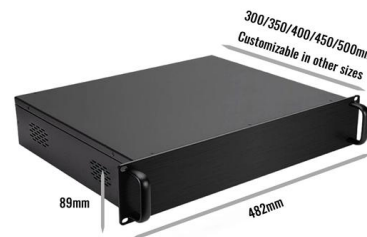

## Artim Metal, Metal Cable Trays, Cable Tray,

40 Series Perforated The 40 Series Perforated is a durable cable management system offering flexibility in installation. Its perforated design increases airflow,

[Contact Us](#)



## Why Galvanized Cable Tray is the Best Option for

Discover why galvanized cable trays are ideal for industrial use, focusing on corrosion resistance, types, and key benefits.

[Contact Us](#)



## Eurostrut Cable Trays , cable tray, cable route and

Strong and durable - Made of hot-dip galvanized steel or stainless steel, suitable for indoor and outdoor applications. Fast installation - Reduce installation costs with

[Contact Us](#)

## HEAVY DUTY CABLE TRAYS - Demka Electrical Suppliers

INTRODUCTION Heavy Duty Cable Trays are used in industrial facilities such as Petrol and Gas facilities. These cable trays are resistant to cable weights.

[Contact Us](#)



## Galvanized Channel Cable Tray System

Galvanized Channel Cable Tray System has the following features and advantages: High strength: GI plate is cold-rolled and hot-dip galvanized, which has high

[Contact Us](#)



### Cable Tray: Material Properties

They are available with various types of corrosion-resistant finishes; usually hot-dip or mill galvanized. The main advantage of utilizing steel in cable tray fabrication is

[Contact Us](#)



### Selecting the right materials for cable tray use at high temperatures

Selecting the right materials for cable tray use at high temperatures From the blistering heat of the Mojave Desert to the sweltering temperatures of foundries, cables need to be supported to ensure

[Contact Us](#)

### Galvanized Cable Tray factory

We have a better understanding of the differences between fire-resistant cable trays and ordinary trays, which will make it easier for people to choose fire-resistant

[Contact Us](#)

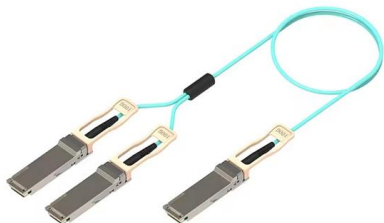

### The Professional Buyer's Guide to Selecting Galvanized

Maximize durability and safety with our professional buyer's guide. Learn how to select the right galvanized cable trays for industrial environments,

[Contact Us](#)



## Why Galvanized Steel Cable Trays Are Ideal for

Why galvanized steel cable trays for industrial cable management? Durable, corrosion-resistant, and cost-effective for harsh conditions.

[Contact Us](#)



## HDG Ladder Cable Tray , Cable Ladder Manufacturer

Hot Dip Galvanized (GI) Ladder Cable Trays are metal trays with a ladder-like design, coated with a layer of zinc through the hot-dip galvanizing process. The

[Contact Us](#)

## Galvanized Cable Trays - Mesh & Steel

Explore an advanced dimension of cable organization with our Galvanized Cable Trays. Meticulously crafted for seamless cable routing and enhanced protection,

[Contact Us](#)



## Contact Us

---

For datasheets, pricing, or custom fiber access solutions, please visit:  
<https://frindel.es>