

# Flame-retardant server racks in Ecuador s overseas warehouse





## Flame-retardant server racks in Ecuador s overseas warehouse

---



### Best Fire Suppression Systems for Server Rooms

Because of the sensitivity of this equipment, fire suppression for server rooms is a top priority. Choosing the best fire suppression system for a

[Contact Us](#)

### RACK

Rack de 6U puerta metálica perforada Copperled. CL-WC-6U - Rack de 6U puerta metálica perforada. Puertas laterales desmontables. Perfil de montaje interior con

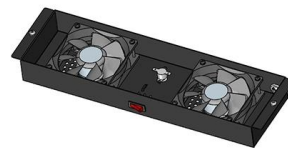

[Contact Us](#)

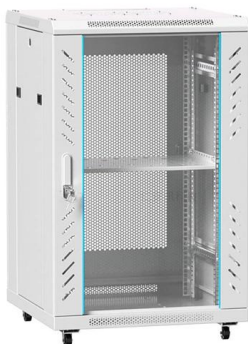

### Rack Servers from 1U to 5U for Data Center Workloads

Rack servers delivering high scalability and flexibility, optimized for demanding data center applications. Available in 1U to 5U rack densities, with support for single and multi-socket configurations for x86

[Contact Us](#)

### Protecting Data Centers from Fire Risks , Flarenix

These facilities often operate at power densities above 15 kW per rack, significantly increasing heat output and fire risk. While cybersecurity and



### **Protecting Server Racks with DLP and ILP Fire**

This article explains how server rack fires start, why early suppression matters, and how DLP and ILP systems are engineered to stop fires at the

[Contact Us](#)

### **Fire Resistance of Steel Rack Frames: Assessment**

Steel rack frames are used to suitably store goods and products and are constructed by means the use of thin-walled cold-formed components. Their competitiveness on the market

[Contact Us](#)



### **Protecting Data Centers & Server Rooms from Fire**

Fires in server rooms can lead to catastrophic data loss, significant financial costs and operational outages. To mitigate these threats, implementing robust

[Contact Us](#)





## Racks de Servidores y Racks de Telecomunicaciones

Gabinetes rack estándar 19" con profundidades variables para servidores, almacenamiento y equipos de telecomunicaciones.

[Contact Us](#)



## The Role of Flame-Retardant Resins in Server Racks

Server racks typically comprise steel or aluminum frames coupled with plastic components such as cable management panels, vented rails, blanking panels, and cable organizers. In the event

[Contact Us](#)

## Server Rack Fire Suppression System , Data Center Protection

Server rack fire suppression systems are specifically designed to detect and extinguish fires within server racks while protecting your valuable equipment. These systems can be found in data centers,

[Contact Us](#)

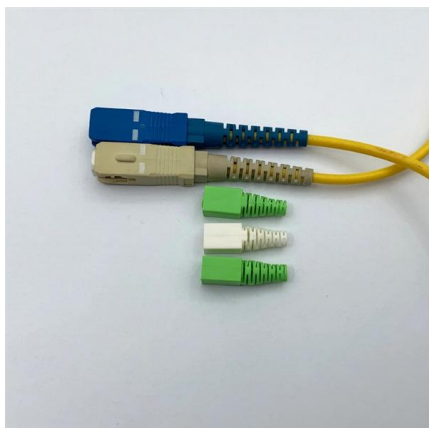
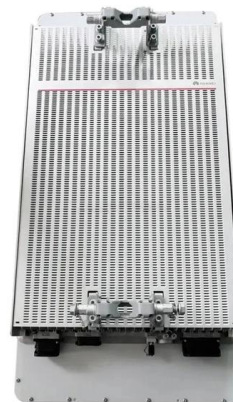

## Fire Safety in Server Rooms: A Critical Layer of

While cyber threats and hardware failures get most of the attention, one of the most devastating yet preventable risks in any server room or data

[Contact Us](#)



## fire protection for server rack and fireproof server safe

Secure fire protection from the outside with our server rack as a separate fire compartment and fire protection from the inside with our 19" extinguishing system

[Contact Us](#)



## Racks

Extremis ofrece las soluciones mas avanzadas de Data Centers en Ecuador. Implementa desde los pisos, puertas, aire acondicionado, sistema para

[Contact Us](#)

## Ecuador Data Center Rack Server Market (2025-2031) , Trends,

Ecuador Data Center Rack Server Market Overview Rack servers are essential in Ecuador`s data centers, providing scalable and efficient computing power. The market for Data Center Rack Servers

[Contact Us](#)

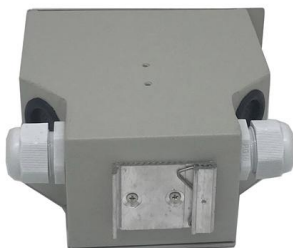
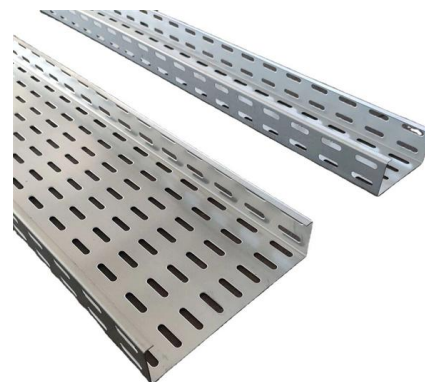

## Fire Safety in Server Rooms: A Critical Layer of

This article highlights essential fire safety considerations for server rooms, combining international best practices with practical insights -- especially

[Contact Us](#)



## The Best Server Room Fire Suppression Systems

The server room is the heart of any organization's IT infrastructure and contains critical hardware, software and data that keep the business running

[Contact Us](#)



## Server Rack Fire Suppression System

Server Rack Fire Suppression System Kitchen Fire Suppression System Restaurant kitchens area unit significantly pre-disposed to fireside hazards. Despite the

[Contact Us](#)



## Network Server Racks for sale in Guayaquil, Ecuador

New and used Network Server Racks for sale in Guayaquil, Ecuador on Facebook Marketplace. Find great deals and sell your items for free.

[Contact Us](#)

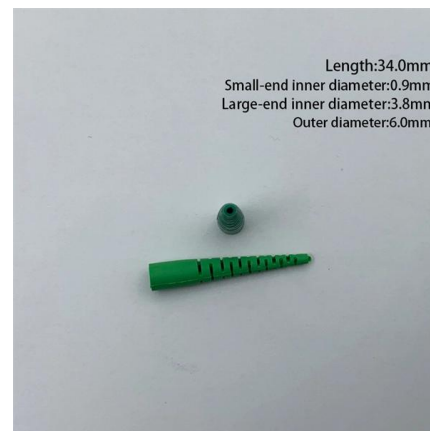

## Racks Ecuador: Fabricantes de Racks Certificados en

Omega Racks, respaldada con el soporte técnico de Procesadora Vymsa, lidera en soluciones modernas de almacenamiento en Ecuador. Ofrecemos racks

[Contact Us](#)



## Fire protection for server rooms

Holistic fire protection for server rooms When determining the fire protection measures for server rooms, the entire building is considered and the

[Contact Us](#)



## Fire protection for server and control cabinets

The self-contained construction of server and control cabinets with numerous electrical components installed inside the cabinets pose a particular challenge for fire protection.

[Contact Us](#)

## Server Room Fire Suppression: A Complete Guide , Sciens

A guide to server room fire suppression systems. Protect your IT infrastructure with gas or water-based solutions and ensure

[Contact Us](#)



## Which Fire Protection System is Best for Server Rooms

The best fire protection system for server rooms and data centers is a clean agent suppression system, such as FM-200 or inert gas system, because

[Contact Us](#)



## 2011 OBO Building Code Supplement , PDF , Consul

This document is the table of contents for the 2011 Building Code of Overseas Buildings Operations. It lists the chapters and sections that are amended or

[Contact Us](#)

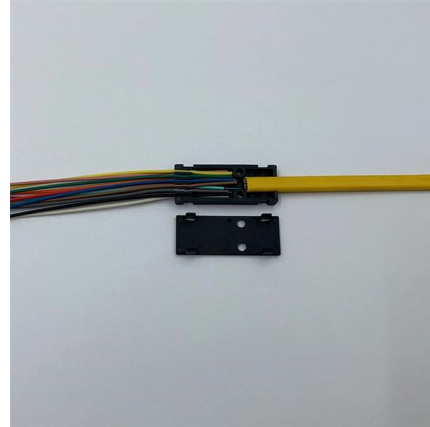

## Nuestra Empresa , Fabricantes de Racks Certificados en Ecuador

En Omega Racks somos fabricantes de racks certificados. Ofrecemos soluciones seguras para almacenamiento industrial y comercial.

[Contact Us](#)

## Which Fire Protection System is Best for Server Rooms

Discover the best fire protection systems for server rooms and data centers. Learn why clean agent suppression systems protect IT infrastructure.

[Contact Us](#)



## Fire protection for server and control cabinets

With this holistic fire protection solution, we initiate the immediate and earliest possible fire detection directly at the server racks with extinguishing technology that is optimally adapted to switch and

[Contact Us](#)



## Server Rack Fire Protection: What You Need to Do Now

From choosing the right enclosures like fireproof server cabinets, to fitting a fire suppression system for server room layouts, we'll cover the best

[Contact Us](#)

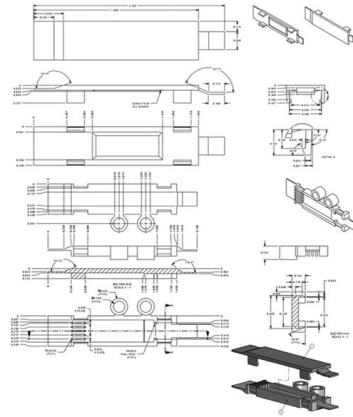

## Contact Us

---

For datasheets, pricing, or custom fiber access solutions, please visit:  
<https://frindel.es>