

# Fiber optic box on utility pole





## Fiber optic box on utility pole

---



### Fiber Optics For Electrical Utilities

Designing Utility Fiber Optic Networks The design of a fiber optic network for an electrical utility requires a coordinated effort between knowledgeable designers

[Contact Us](#)

### Outdoor Fiber Optic Enclosures , IP67, Wall & Pole

Protect your fiber with Amphenol FOP's rugged outdoor enclosures-IP67-rated, wall- and pole-mount with integrated cable strain relief and corrosion-resistant design.

[Contact Us](#)



### The FOA Reference For Fiber Optics -Outside Plant Construction

Deploying fiber above ground on poles or towers removes the need for underground digging and is particularly useful when the ground is uneven, rocky or both. Aerial installation is generally much less

[Contact Us](#)

### Fiber Optic Jobs, Employment , Indeed

10,477 Fiber Optic jobs available on Indeed .  
Apply to Network Engineer, Installer, Splicer and more!

[Contact Us](#)





### Fiber Optic Terminal Box on Utility Pole

Find durable fiber optic terminal boxes on utility poles with IP65 waterproofing, pole mounting, and customizable options. Click to explore top suppliers and secure your network today.

[Contact Us](#)

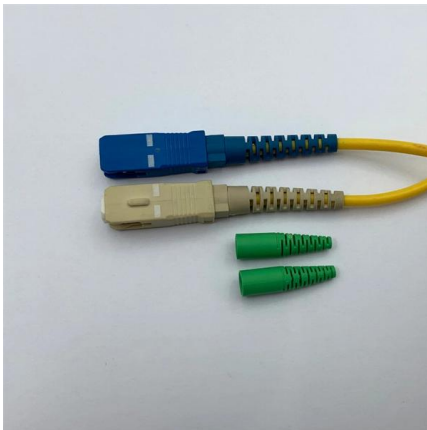

### Cable television

A cable television distribution box (left) in the basement of a building in Germany (Kabel BW network, now Vodafone), with a splitter (right) which supplies the

[Contact Us](#)



### Aerial Cable ID

Fiber optic communication often converts downstream to telephone cables, but this requires large cabinets which are going to be ground-mounted. However, fiber

[Contact Us](#)





## Fiber installation guide , Ziplly Fiber

This indoor placement can offer better protection for the device and easier access for any future maintenance. 3. Fiber-optic

[Contact Us](#)

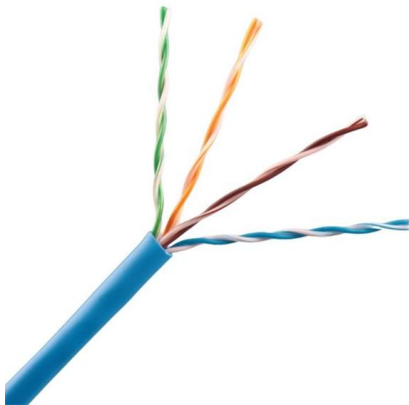

## Fiber box on utility pole : r/Spectrum

My area is part of the rural fiber buildout. A couple months ago the fiber lines were installed on utility poles in my area. Today I noticed a new box on the utility poles.

[Contact Us](#)

## FIBER OPTIC CONSTRUCTION STANDARDS

Fiber optic cable sequential numbers are required at each pole location and vault wall. Sequential numbers will identify conduit length, and slack left in vaults and at poles.

[Contact Us](#)

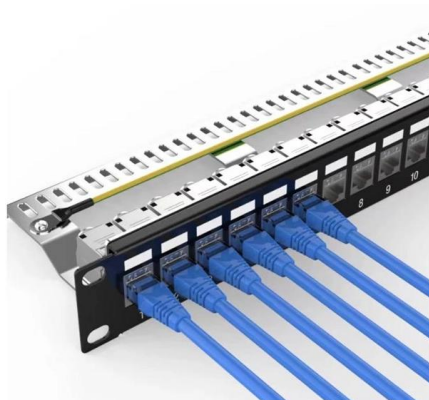

## 16 Core Outdoor Fiber Optic Distribution Box IP65 FDB FTTH Terminal Box

This 16-core Fiber Distribution Box (FDB) is a professional outdoor optical termination enclosure designed for FTTH access networks. Made of high-quality PC+ABS plastic with UV-resistant and

[Contact Us](#)

**Is this what fiber looks like on a utility**



**pole? :**  
 Is this what fiber looks like on a utility pole? I recently noticed this next to the utility pole that services my home. Is this fiber? And if so, is there anything I can do to

[Contact Us](#)



**FCST022113 Fiber Access Terminal Closure - IP68 FTTX Termination Box**

FCST022113 fiber access terminal closure, IP68 rated, PP+GF material. Supports 24 splice capacity, 4 core branch (SC), gel sealing, wall or pole mount. Ideal for FTTX network termination. Get factory

[Contact Us](#)



**The FOA Reference For Fiber Optics**

Just like "wire" which can mean lots of different things - power, security, HVAC, CCTV, LAN or telephone - fiber optics is not all the same. Since all these

[Contact Us](#)



**Fiber Optic Cable Installation: Underground vs Aerial , Langzhi**

Underground vs aerial fiber optic cable installation compared. Costs, durability, maintenance requirements, and guidance on choosing the right method.

[Contact Us](#)





## 8 Core NAP ODP FTB FTTH 3 Inlet Fiber Access

The 8 port Fiber Distribution Box is sturdy in structure, lightweight in size, and easy to install. It can be installed on walls or utility poles, and its waterproof cover

[Contact Us](#)



## Wall-Mount vs Pole-Mount Fiber Boxes Technical Guide

Pole-mounted fiber boxes are installed on utility poles, telecom poles, and street-level infrastructure, requiring superior mechanical and environmental

[Contact Us](#)

## Fiber Optic Splicing Contractor Jobs, Employment , Indeed

Fiber Optic Installation Electricians - TravelHigh Pay Available! United Trades of America is hiring Journeyman Electricians and Apprentices with fiber optic installation experience for work based in

[Contact Us](#)

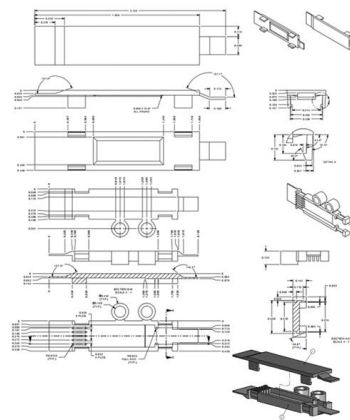

## Optical ground wire

An optical ground wire (also known as an OPGW or, in the IEEE standard, an optical fiber composite overhead ground wire) is a type of cable that is used in overhead power lines.

[Contact Us](#)



## Outdoor Fiber Installation Practices Explained for 2025

Aerial fiber optic cable installation is ideal for areas with existing utility poles or where ground disturbance is not practical. You suspend the cable above

[Contact Us](#)



## Fiber Optic Jobs, Employment in Alabama , Indeed

218 Fiber Optic jobs available in Alabama on Indeed . Apply to Cable Installer, Network Engineer, Cable Technician and more!

[Contact Us](#)

## Outdoor Telecom Enclosures & NEMA Cabinets , AmProd

Fiber Optic Pole Mount Slack Storage Enclosure  
This all-metal pole-mount enclosure stores up to ~250? (144-count) of outdoor fiber slack. Powder-coated steel and

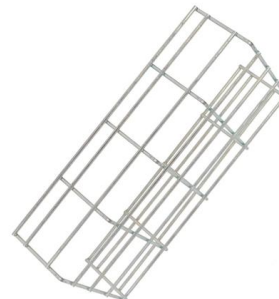

[Contact Us](#)

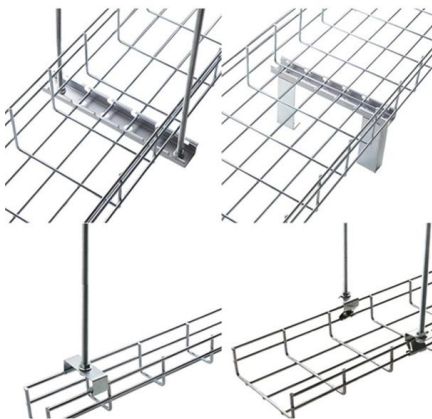

## The FOA Reference For Fiber Optics

Passive loss is made up of fiber loss, connector loss, and splice loss. Don't forget any couplers or splitters in the link. If the specifications for a type of system or

[Contact Us](#)



## OYI INTERNATIONAL LTD

Oyi international., Ltd. is a dynamic and innovative fibre optic cable company based in Shenzhen, China. Since its inception in 2006, OYI has been dedicated to

[Contact Us](#)



### Fiber to the x

Fiber to the premises (FTTP) is a form of fiber-optic communication delivery in which an optical fiber is run in an optical distribution network from the central office all

[Contact Us](#)

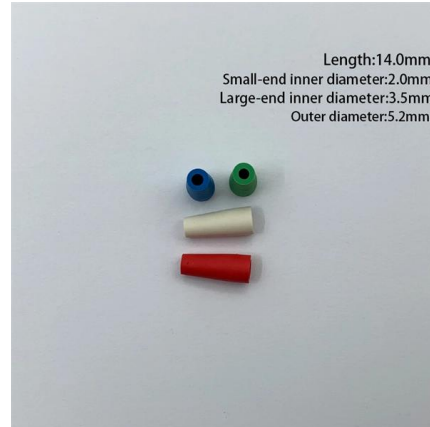

### Mixing Fiber and Power Lines in Aerial Fiber Deployments

One way round this is to install aerial fiber cables close to power lines, such as on mixed use poles which also carry electricity.

[Contact Us](#)

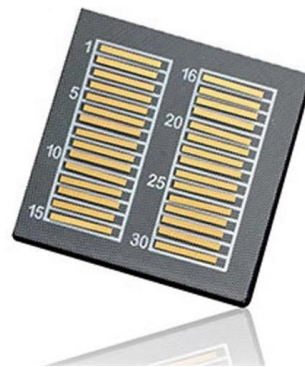

## Contact Us

For datasheets, pricing, or custom fiber access solutions, please visit:  
<https://frindel.es>