

Fiber Optic Type and Specifications Single Mode





Overview

In, a single-mode optical fiber, also known as fundamental- or mono-mode, is an designed to carry only a single of light - the. Modes are the possible solutions of the for waves, which is obtained by combining and the boundary conditions.



Fiber Optic Type and Specifications Single Mode



Single Mode vs. Multimode Fiber Optic Cables

There are two main types of fiber optic cables: single mode and multimode. Although they can do the same job in some instances, the different

[Contact Us](#)

Fiber Optic Cable

Fiber Cable Belden's extensive line of indoor and outdoor cable products is offered in tight buffer and loose tube designs. Armored, burial, and ruggedized designs are

[Contact Us](#)



1x16 Single Mode Fiber Optic Splitters

Mount to an Optical Table with the FCQB Mounting Base (Available Below) Thorlabs' Single Mode 1x16 Fiber Optic Planar Lightwave Circuit (PLC) Splitters allow a

[Contact Us](#)

OS1, OS2 vs OM1-OM5 Fiber Cables: Differences, Speeds, and

Explore the differences between OS1, OS2 (single-mode) and OM1, OM2, OM3, OM4, OM5 (multimode) fibers. Learn their speeds, distances, and ideal uses for data centers and telecom networks.



Fiber Optic Cable Types: A Complete Guide

The plethora of fiber optic cable types can seem overwhelming, but choosing the right cable for the job is important.

[Contact Us](#)



5 Types of Single-Mode Fiber: Understanding Your Options

Learn about the different types of single-mode fiber for optimized network performance. Find out which fiber type suits your specific connectivity

[Contact Us](#)



6 Strand Single Mode Outdoor Fiber Optic Cable Buying Guide

Choose 6 strand single mode outdoor fiber optic cable by OS2 fiber, jacket, strength member, water blocking, drum length, and installation.

[Contact Us](#)





SFP Fiber Optic Connector Types: LC, SC, MPO Explained

Explore common SFP fiber optic connector types, including LC, SC, and MPO/MTP. Learn their differences, use cases, and compatibility.

[Contact Us](#)

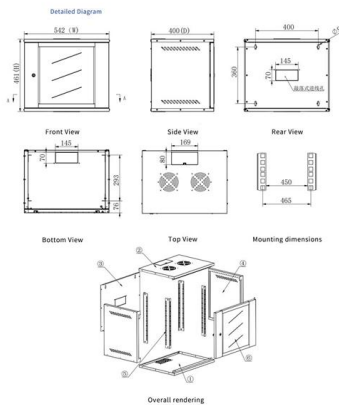

Fiber Optic Cable Pricing Guide: Factors That Affect

Fiber optic cables are essential components in today's broadband, FTTx, and data center networks. Whether you're planning a national fiber rollout

[Contact Us](#)



IP65 / IP67 Sealing Design



Reserved Bottom Mounting Holes

12 Core Single Mode Fiber Optic Cable for Backbone Projects

Product Parameters B2B Buyers Should Confirm For 12 core single mode fiber optic cable, the buyer should confirm fiber standard, core count, jacket material, armor option, tensile strength,

[Contact Us](#)



Recommendation ITU-T G.652 (08/2024)

This document outlines the specifications for a single-mode optical fiber and cable designed for use around the 1310 nm zero-dispersion wavelength, suitable for

[Contact Us](#)



Single-Mode Fiber Cable Guide: Types, Specs & Selection

This comprehensive guide explores Single-Mode Fiber Optic Cable, covering technical specifications, deployment scenarios, and best practices to help you optimize your fiber infrastructure

[Contact Us](#)



Cost of Fiber Optic Cable: Pricing Guide (2026)

Discover the cost of fiber optic cable in this pricing guide. Learn material prices, installation factors, and what impacts total project costs overall.

[Contact Us](#)

Fiber Optic Cable Types , Omnitron Systems Guide

Explore fiber optic cable types, features, and applications. Omnitron Systems explains single-mode, multi-mode, and specialty fiber solutions.

[Contact Us](#)

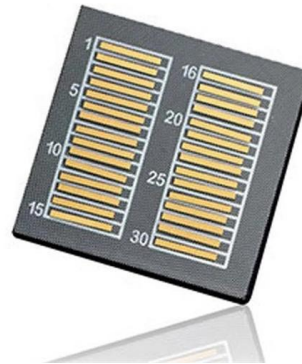

Wall Mount Cabinet Server Racks

Glass Door, Cam Lock



Fiber Optic Color Code: The Ultimate TIA-598-C Guide

Master the TIA-598-C fiber optic color code standard. Read our complete guide and use our free interactive calculator to easily identify 1-144 core cables.

[Contact Us](#)



FO Cable Patchcord 12C OS2 Type-B OFNP 30m Corning

Fiber Optic Patch Cable, Fiber Optic Patchcord MPO-MPO F to F 12 Cores Type B Single Mode OS2 Corning G657A1 Low Loss 0.35dB Max 3.0mm OFNP Plenum 30m (98ft) Specifications Stay



[Contact Us](#)



OM1 vs OM2 vs OM3 vs OM4 vs OM5 Multimode Fiber

Compare OM1, OM2, OM3, OM4, and OM5 multimode fiber specs, distances, bandwidth, and applications. Essential guide for data center fiber

[Contact Us](#)

OS1 vs OS2, OM3 vs OM4 vs OM5 - Fiber Optic Cable

Discover the key differences between OS1 and OS2 singlemode fibers, and OM3, OM4, OM5 multimode cables. Learn how to select the right fiber type

[Contact Us](#)

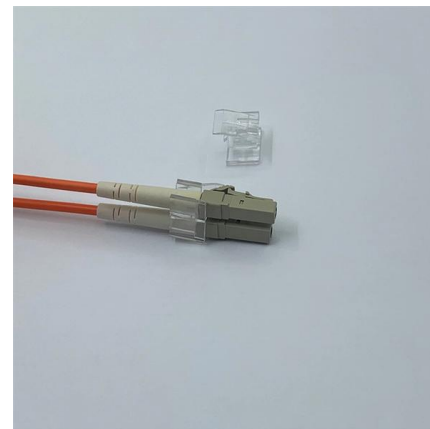

24 Cores GYTS Fiber Optic Cable Stranded Steel Tape

24 Core GYTS Fiber Optic Cable is the outdoor fiber optic cable type used for duct and aerial applications. We supply single mode GYTS fiber optical cable and

[Contact Us](#)



Guide to Single Mode Fiber Types: G.652, G.655, G.657 Explained

Learn about the main single mode fiber types including G.652D, G.655, G.656, and G.657. This guide explains their differences, typical applications, bend performance, and OS1 vs

[Contact Us](#)



Single-mode optical fiber

OverviewHistoryCharacteristicsConnectorsFiber optic switchesQuadruply clad fiberExternal links

In fiber-optic communication, a single-mode optical fiber, also known as fundamental- or mono-mode, is an optical fiber designed to carry only a single mode of light - the transverse mode. Modes are the possible solutions of the Helmholtz equation for waves, which is obtained by combining Maxwell's equations and the boundary conditions. These modes define the way the wave travels through space, i.e. how the wave is distributed in space. Waves can have the same mode but have different frequencies. This is the case i

[Contact Us](#)

What are the key specifications of single-mode fiber

Explore the essential specifications of single-mode fiber optic cables, including core size, attenuation rates, bandwidth capabilities, and standard

[Contact Us](#)



IP65 / IP67 Sealing Design



Reserved Bottom Mounting Holes

The FOA Reference For Fiber Optics

The usual fiber specifications are size (core/cladding diameter in microns), attenuation coefficient (dB/km at appropriate wavelengths)



and bandwidth (MHz)

[Contact Us](#)



Fiber Optic Patch Cable, Duplex FC UPC, NK to SC UPC, SM OS2,

Pasternack's PE3FCA521-5M fiber optic patch cord is a robust and versatile fiber optic cable assembly designed for high-performance data transmission in various environments. This 5-meter long duplex

[Contact Us](#)

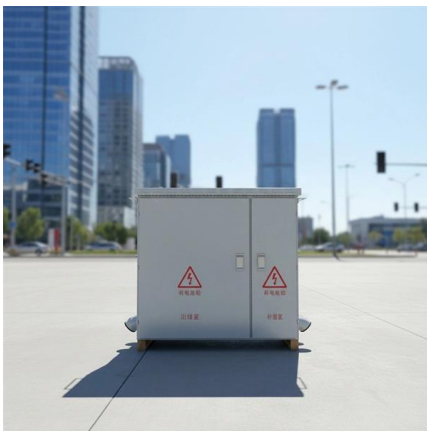
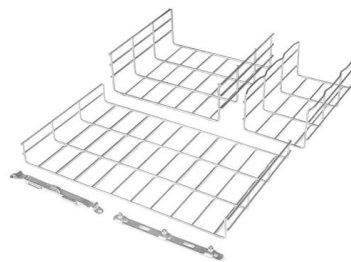

Single Mode Fiber: Types and Applications

Single mode fiber (SMF) is a type of fiber optic cable that only allows one light mode to transmit at a time. Generally, single

[Contact Us](#)

Fiber Optic Cable Types Explained

Our comprehensive guide to types of fiber optic cables. Learn all about the differences between single mode and multimode cables, as well as the various

[Contact Us](#)

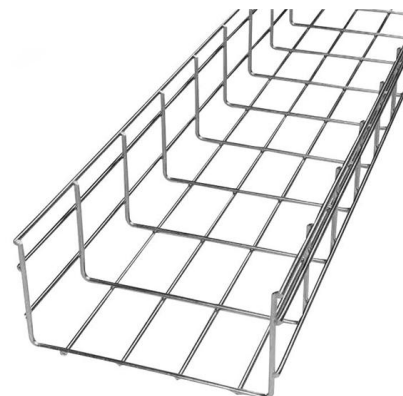



6 Core Single Mode Fiber Optic Cable Buying Guide

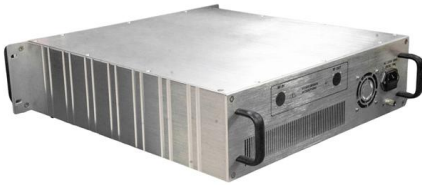

People searching for 6 core single mode fiber optic cable usually have a practical procurement or engineering problem. The main pain is that buyers can choose the right core count

[Contact Us](#)

Fiber Panels, Modules & Cassettes

Explore CommScope's efficient and scalable fiber splice panels designed for seamless connectivity. Accommodating LC, SC, and MTP/MPO connectors,

[Contact Us](#)



Single-Mode Optical Fiber (SMF)

Draka Single-Mode Fiber (SMF) provides optimum performance in both the 1310 nm and 1550 nm wavelength operation ranges (including the 1565 - 1625 nm L-band), with a low dispersion in the

[Contact Us](#)

Contact Us

For datasheets, pricing, or custom fiber access solutions, please visit:
<https://frindel.es>