

Croatia Aggregation Switch 100G





Overview

8 Tbps high-density 100G/25G Layer 3 Etherlighting™ aggregation switch with MC-LAG support for high availability system design. Requires a 4-post rack, or a center-mount bracket or cantilever shelf on 2-post racks for optimal support.



Croatia Aggregation Switch 100G



Aggregation Switches , D-Link

Provides advanced Security ACLs for improved security, traffic control, and QoS, ensuring efficient and optimized networking.

[Contact Us](#)

Ubiquiti UniFi ECS-Aggregation 54-Port 100G L3 Managed Switch

Shop online and read reviews for Ubiquiti UniFi ECS-Aggregation 54-Port 100G L3 Managed Switch - QSFP28 x6, SFP28 x48 (ECS-Aggregation) at PBTech



[Contact Us](#)



Ubiquiti Enterprise Campus Aggregation Switch

1.8 Tbps high-density 100G/25G Layer 3 Etherlighting(TM) aggregation switch with MC-LAG support for high availability system design. (48) 25G SFP28 and (6) 100G

[Contact Us](#)

Ubiquiti ECS-Aggregation Specifications

Ubiquiti ECS-Aggregation UniFi Enterprise Campus 48-Port L3 Managed 25G SFP28 Aggregation Switch w/ 6 x 100G QSFP28 Ports, Specifications

[Contact Us](#)



Ubiquiti UniFi Enterprise Campus Aggregation - 100G Switch

Der Ubiquiti UniFi Enterprise Campus Aggregation Switch ist ein leistungsstarker Aggregation-Switch für große Netzwerke. Mit 48x (25G/10G) SFP28 Ports und 6x (100G/40G) QSFP28 Ports ermöglicht er

[Contact Us](#)

Ubiquiti Switch Aggregation

Ubiquiti Switch Aggregation fanless 8-port Layer 2 switch for 10G SFP+ connections with silent cooling. Order at NAS STORE.

[Contact Us](#)

LoRa handheld portable base station

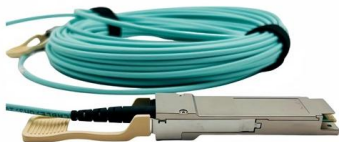

Ubiquiti UniFi 48-Port 25G SFP28 Aggregation Switch

The Ubiquiti UniFi ECS-AGGREGATION is a 48 port L3 managed aggregation switch with 48 x 25G SFP28 and 6 x 100G QSFP28 ports.

[Contact Us](#)

Extending the 100G Edge



Introducing Ciena's new 5171 Service Aggregation Switch and Service Aggregation Platform, bringing more capacity closer to the network edge,

[Contact Us](#)

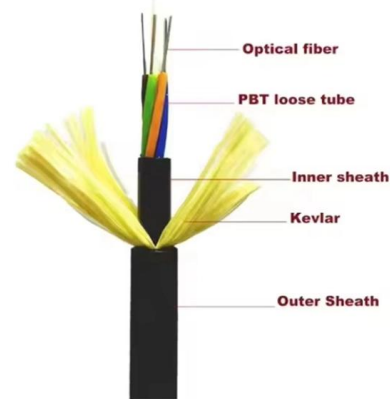

Switch Hi-Capacity Aggregation

A 32-port, Layer 3 switch made for high-capacity 10G SFP+ and 25G SFP28 connections.

[Contact Us](#)

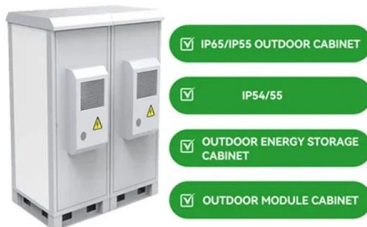

Enterprise Campus Aggregation (ECS-Aggregation)

The 1.8 Tbps Etherlighting(TM) aggregation switch delivers high-density connectivity with 48x 25G SFP28 and 6x 100G QSFP28 ports, making it ideal for large-scale

[Contact Us](#)



ECS-AGGREGATION, Ubiquiti Enterprise Campus

Large distributor of Ubiquiti Network Switches. Same-day shipment.

[Contact Us](#)



Ubiquiti Enterprise Campus Aggregation



(ECS-Aggregation)

Product Description 1.8 Tbps high-density 100G/25G Layer 3 Etherlighting aggregation switch with MC-LAG support for high availability system design.

[Contact Us](#)

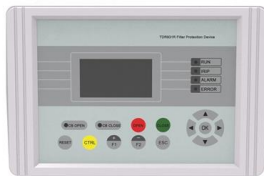
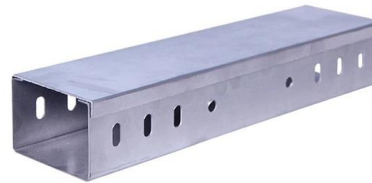

What Is an Aggregation Switch and How to Choose?

An aggregation switch is a network device that consolidates traffic from multiple access switches, wireless access points, or other edge devices and

[Contact Us](#)

LANCOM YS-7154CF: LANCOM Systems GmbH

Der 100G Stackable Fiber Aggregation Switch ist ideal für hohe Leistungsansprüche und maximale Ausfallsicherheit in verteilten Campus-Netzwerken.

[Contact Us](#)



Ubiquiti ECS-Aggregation High-Density 1.8 Tbps Layer 3

The Ubiquiti ECS-AGGREGATION is a high-performance aggregation switch designed for large-scale network environments. It offers a robust 1.8 Tbps switching capacity and supports 100G and 25G

[Contact Us](#)



Aggregation Switch

An aggregation switch refers to a type of switch used to connect multiple ToR switches to a core switch/router in a cloud data center network. It enables high-bandwidth aggregation ports to be

[Contact Us](#)



Ubiquiti ECS-Aggregation High-density 100G/25G Layer 3

Networking Specifications Number of Ports 48 x (25 Gbps) 6 x (100 Gbps) Switching Layers Layer 3 Network/Transport Protocol DHCP IGMP RSTP STP IPv4 ARP Networking Features Port Mirroring

[Contact Us](#)



Ubiquiti's Long-Awaited 100Gb/s Switches: A

Ubiquiti has finally released its long-anticipated 100Gb/s switches, featuring redundant power supplies, high switching capacity, and multi-link

[Contact Us](#)



Switche , 100G

MikroTik Ethernet Switche für 100G Netzwerke , mikrotik-store Preis absteigend Alle Hersteller Seite 1 von 1

[Contact Us](#)

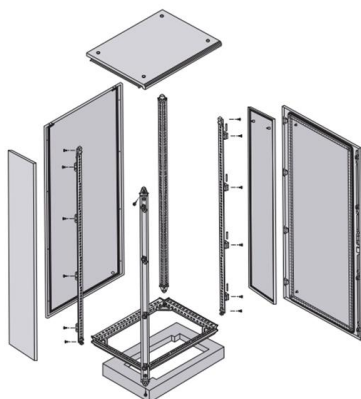

100G Switch Guide - Benefits, Features,



and Use Cases

Learn about 100G switches, their benefits, and how they enhance networking performance in enterprise environments.

[Contact Us](#)



100G-ready Aggregation Switch with distributor price

100G-ready Aggregation Switch with distributor price, Achieve greater efficiency and speed with Layer 3 managed switches equipped with 10G uplink. Perfect for demanding environments where

[Contact Us](#)



1.8Tbps high density 100G/25G Layer3Etherlighting aggregation switch.

1.8 Tbps high-density 100G/25G Layer 3 Etherlighting(TM) aggregation switch with MC-LAG support for high-availability system design.

[Contact Us](#)



Enterprise-Grade 100Gb Networking? UniFi ECS Aggregation Switch

<https://lawrence.video/unifi> UniFi Affiliate Link?
<https://lawrence.video/unifi-affiliate/> UniFi steps into the 100Gb networking space with the Enterprise C

[Contact Us](#)



Ubiquiti Enterprise Campus Aggregation 54-Port 25G/100G

Ubiquiti ECS-Aggregation, a 48-port 25G/100G switch with 1.8 Tbps throughput, Layer 3 routing, and MC-LAG support. Ideal for high availability and scalability.

[Contact Us](#)



AGR100

The AGR100 offers Layer 2 or Layer 3 switching across 48 x 10 GbE ports and 6 x 100G uplinks. This switch can be utilized as a Top-of-Rack switch, as a

[Contact Us](#)

UniFi Enterprise Campus Aggregation

1.8 Tbps high-density 100G/25G Layer 3 Etherlighting(TM) aggregation switch with MC-LAG support for high availability system design.

[Contact Us](#)

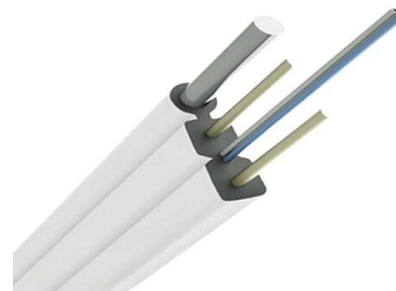

Switch Enterprise Campus Aggregation

1.8 Tbps high-density 100G/25G Layer 3 Etherlighting(TM) aggregation switch with MC-LAG support for high availability system design. Note. Requires a 4-post rack, or a center-mount bracket or cantilever

[Contact Us](#)



Ubiquiti ECS-Aggregation Switch Unboxing

The Ubiquiti ECS-Aggregation Switch is a high-density, high-performance Layer 3 Ethernet aggregation switch designed for large-scale

[Contact Us](#)



What Is an Aggregation Switch and How to Choose?

An aggregation switch is a network device that consolidates traffic from multiple access switches, wireless access points, or other edge devices and forwards it to

[Contact Us](#)

Contact Us

For datasheets, pricing, or custom fiber access solutions, please visit:
<https://frindel.es>