

Columbia Single-Core Pigtail Fiber Manufacturer Direct Sales Point

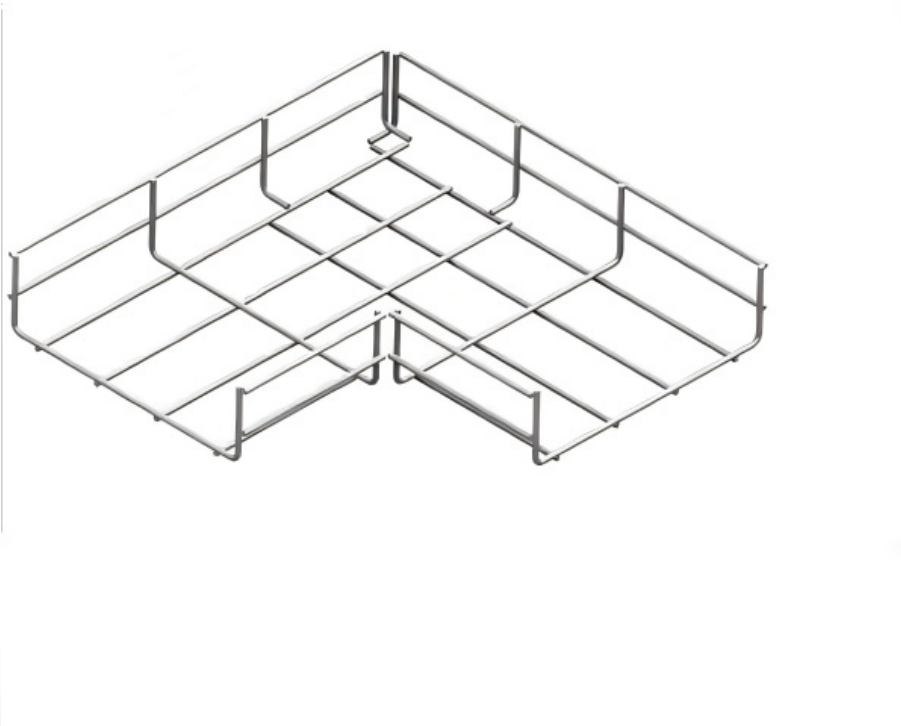



Columbia Single-Core Pigtail Fiber Manufacturer Direct Sales Point



12 core SC/APC single mode Fiber pigtail

We are a manufacturer of 12 core SC/APC single mode Fiber pigtails in competitive cost and short lead time. Our factory approved ISO9001:2015, and we have UL,

[Contact Us](#)

Fiber Optic Pigtail SM Single Mode SC/APC , Fiber4u Technologies ,

For over 20 years, Fiber4u has been a leading provider of fast, cost-effective solutions in Fiber Optics, Rack Cabinets, and Copper network products.

[Contact Us](#)

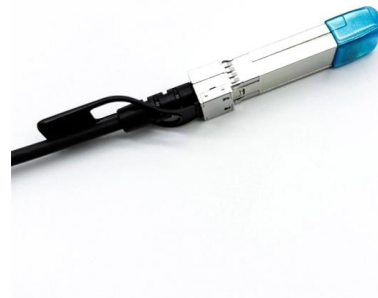

Amazon : Fiber Pigtail Cable, Single Mode SC/UPC Square Head Fiber

SC12 CORE BUNDLE PIGTAIL: using high-quality ceramic ferrule, low insertion loss, large return loss, higher reliability, better stability, better coaxiality and dimensional accuracy. SINGLE-MODE SINGLE

[Contact Us](#)



How to choose fiber optic pigtails?

Applications Fiber optic pigtails are used to terminated fiber optic cables via fusion splicing or mechanical splicing as shown in the picture below. The end of the

[Contact Us](#)



Simplex SC/UPC Single Mode Fiber Optic Pigtail

Description Simplex SC/UPC 9/125 Single Mode Fiber Optic Pigtail
Fiber optic pigtails provide a fast way to make communication devices in the field.

[Contact Us](#)



12 Fiber LC/UPC Pigtail

This is a high-quality singlemode OS2 9/125µm fiber optic pigtail featuring LC/UPC connectors. Built with premium zirconia ferrules and durable composite hardware,

[Contact Us](#)



SC/APC Singlemode Fiber Pigtail - Procurement Guide

We are a professional SC/APC Singlemode Fiber Pigtail manufacturer and supplier based in China. For over 10 years, we've supplied FTTH solutions to

[Contact Us](#)





FIS Distribution Pigtail, 12 Fiber, Singlemode, SC/UPC, Blue Boots, 3

FIS pigtailed feature low insertion loss, low back reflection, and color-coded 900um tight buffered fibers. Stock pigtail configurations are available with your choice of LC, SC or ST fiber optic connectors and

[Contact Us](#)

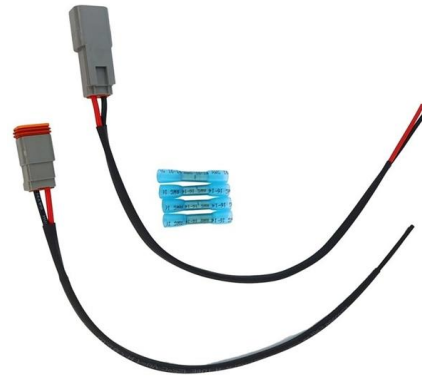

Fiber Optic Pigtailed Models and Selection Guide

The choice of these models directly affects the transmission efficiency, stability and reliability of the fiber optic network. Understanding the

[Contact Us](#)

Fiber Optic Pigtailed , SC, LC, ST Single Mode & Multimode

Find high-quality fiber optic pigtailed for reliable network termination. We offer a full range of single mode and multimode pigtailed with SC, LC, ST, and FC connectors.

[Contact Us](#)



12-Core SC Pigtail , FiberMania OEM

This SC/UPC 12-core fan-out fiber optic pigtail is designed for efficient fusion splicing in fiber distribution frames, patch panels, and terminal boxes. Manufactured with high-precision single-mode 9/125 um

[Contact Us](#)



Fiber Pigtaills

CommScope engineers and manufactures a complete line of high quality fiber pigtaills

[Contact Us](#)



Single mode & Multimode Fiber Pigtaills for Sale

FS offers single mode & multimode fiber pigtaills with tight buffer design for easy fusion or mechanical splicing. Quality assurance by 100% end-face, IL & RL testing.

[Contact Us](#)



What is a Fiber Optic Pigtail, and What Is It Used For?

Discover the essentials of fiber optic pigtaills, including types, uses, and installation procedures to ensure smooth network operations in data and

[Contact Us](#)

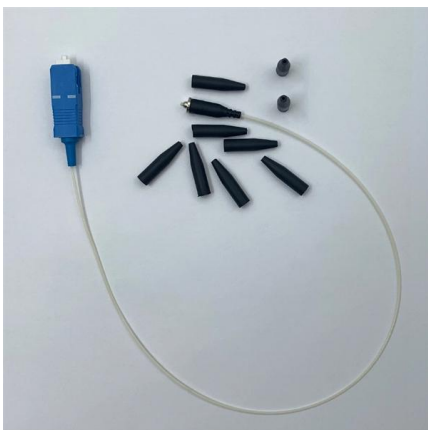

Buy Simplex SC/UPC Single Mode Fiber Optic Pigtail

Simplex SC/UPC Single Mode Fiber Optic Pigtail are designed, manufactured and tested according to protocol and performance dictated by the industrial standards.

[Contact Us](#)



Fiber Optic Pigtail Meaning:What is it and How to

Fiber optic pigtail is an unbuffered optical fiber that has one end terminated with a fiber optic connector and the other end for splicing.

[Contact Us](#)

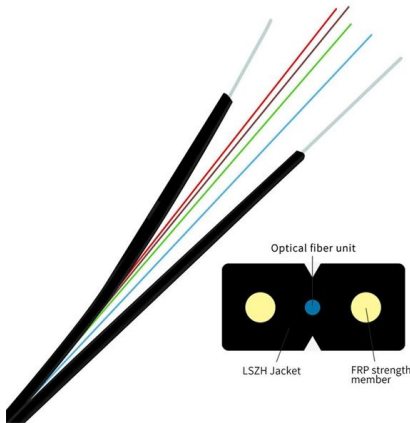

12 Colored Fiber Optic Pigtail SM Single Mode SC/UPC

12 Colored Fiber Optic Pigtail SM - SC/UPC 1.5 Meters Product Features: Fiber Type: Single Mode (SM) Number of Cores: 12 Color: 12 different colored fiber

[Contact Us](#)

Fiber Optic Pigtail Connector, Single Mode & Multimode

A fiber optic pigtail is a short length of fiber optic cable that is terminated with a fiber optic connector on one end and has exposed fibers on the other end.



[Contact Us](#)



Fiber Optic Pigtails for Sale

FS fiber optic pigtails offer a fast way to make fiber optic communication devices in the field by fiber splicing, fully manufactured and tested by industrial standards.

[Contact Us](#)



Fiber Optic Pigtails , SC, LC, ST Single Mode & Multimode

Fibertronics, Inc. offers a range of competitively priced fiber optic pigtails. Our selection includes three main fiber variants: 9/125um single mode, 62.5/125 multimode, and 50um OM3, OM4, and OM5.

[Contact Us](#)



Fiber Optic Pigtail , Precise Termination for Fiber Networks

From multimode fiber pigtail solutions for data-intensive environments to single mode fiber pigtails tailored for long-haul transmission, Unisol delivers performance you

[Contact Us](#)

Single Mode and Multimode Fiber Pigtails (6 or 12 Fibers)

High quality pre-terminated 900µm optical fiber pigtails with LC, SC, ST connectors for fiber splicing applications. Choose from single mode, multimode and 10G OM3/OM4 fibers.

[Contact Us](#)



Fiber Pigtail Singlemode & Multimode SC LC FC ST

Fiber optic pigtail is a fiber optic cable preterminated with a fiber optic connector on one end, the other end is blunt. So a fiber optic pigtail is often used to connect a

[Contact Us](#)



Pigtail Fiber: The Backbone of Modern Optical Networks

Pigtail Fiber: The Backbone of Modern Optical Networks - A Comprehensive Guide for 2025 In the era of hyperconnectivity, where data centers, 5G networks, and AI-driven applications

[Contact Us](#)

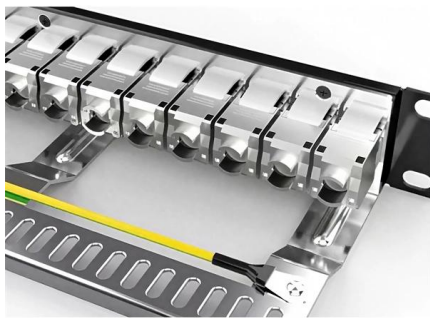

Fiber Pigtail Singlemode & Multimode SC LC FC ST

According to the fiber types, There are Singlemode fiber optic pigtails and Multimode fiber optic pigtails. every fiber optic pigtail varies from different fiber connectors.

[Contact Us](#)

Global Manufacturer & Supplier of SC/APC Fibre Pigtail

Buy SC/APC Fibre Pigtail at the best price from Norden Communication, the global manufacturer and supplier of electrical and optical solutions. Choose Norden for the worldwide supply of SC/APC Fibre

[Contact Us](#)



Fiber Optic Pigtail Connector, Single Mode & Multimode

The fiber type denotes the type of fiber in the optical cable, including single mode and multimode fiber optic pigtail. Additionally, they can be classified according to

[Contact Us](#)



Iveonet (TM)

Fiber Optic Pigtail assemblies are utilised in terminating fiber optic cables via fusion splicing. Iveonet (TM) offers a wide range of pigtails, designed and manufactured for

[Contact Us](#)

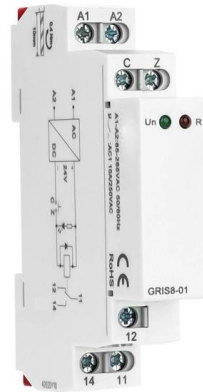

Contact Us

For datasheets, pricing, or custom fiber access solutions, please visit:
<https://frindel.es>