

Cable tray 45 bend fabrication





Cable tray 45 bend fabrication



How to Make an Internal Bend in Steel Cable Tray Using a

You can buy a manufactured 90 degree bend or make one on a cable tray bending machine but in this video I show you how to make one using a metal bar.

[Contact Us](#)

SPF530VHB4548 , Bend for cable tray , T&B Cable Tray , Wire & Cable

Pre-galvanized steel fitting 5 inches side rail height 30 inches width ventilated horizontal bend 45 degree 48 inches radius For more info visit: electrification .abb

[Contact Us](#)

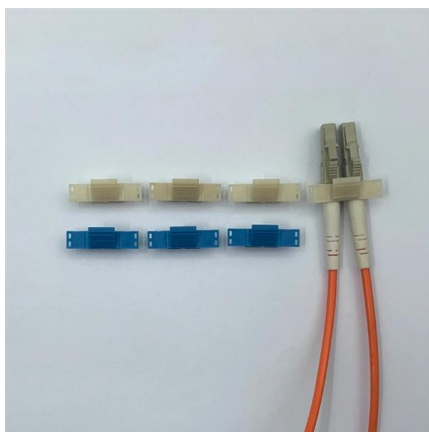

Steel Cable Tray Fabrication & Accessories for Cable

Get premium steel cable trays and accessories from Build Matt in Uganda. We offer bespoke steel fabrication services for ladder, perforated, and solid bottom trays

[Contact Us](#)

How to fabrication 200 mm cable tray bend

Marking the Bend Angle: Decide the angle of the bend (commonly 90° or 45°). On a flat sheet, mark the centerline and sides of the tray (200 mm width).

[Contact Us](#)



Custom plastic fabricators Frankfurt am Main and Hesse

130 Companies and suppliers for custom-plastic-fabricators Find wholesalers and contact them directly Leading B2B marketplace Find companies now!

[Contact Us](#)



Cable Tray

Manufacturer of Cable Tray - 45 Degree Horizontal Bend Ladder, 90 Degree Vertical Bend Perforated Cable Tray, Cable Tray Accessories Bench and Horizontal Bend Perforated Cable Trays offered by

[Contact Us](#)

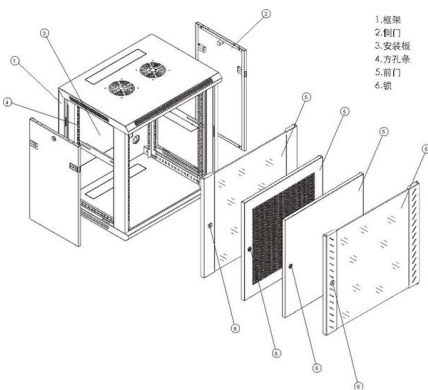

cable tray bends and offset fabrication table

Resources For Electrical & Electronic Engineers cable tray bends and offset fabrication table Discover more from Electrical Engineering 123 Subscribe to get the latest posts sent to your email.

[Contact Us](#)

Spline Cable Kit Vol.01 , Fab



It contains a variety of cables, plugs and a cable tray kit. All cables used in combination with the spline blueprint included allow you to bend them however you like. The cables were made with the intention

[Contact Us](#)



Cable Tray 45 Degree Offset Formula , How to Make 45 Degree

How to make 45°degree OFFSETS cable tray (50mm depth) Practical Tutorial 2 How to make a 45 degree bend in a cable tray. How to make a halfset in a cable tray

[Contact Us](#)

Cable Tray Offset Formula , How To Make Cable Tray Offset Bend

How to make 45°degree OFFSETS cable tray (50mm depth) Practical Tutorial 2 Cable Tray Side Offset Calculation Formula , Complete Explanation in Hindi Cable Tray 3 Cut 90 Degree Bend !!

[Contact Us](#)



Assembly Guide

Assembly Guide The bends, tees, crosses, risers and reducers of wire mesh cable tray can be easily and quickly made live at the project by using a bolt cutter. Since the jaws of the bolt cutter drags a

[Contact Us](#)



Cable tray 45 degree bend , Cable tray me offset kaise banaye

Cable tray 45 degree bend , Cable tray me offset kaise banaye , Cable tray offset formula Queries Solved in This Video:cable tray offset,cable tray bend cable

[Contact Us](#)



Company Overview

Beijing Oriens Technology Co., Ltd.
Products:metal stamping parts, sheet metal fabrication, metal bending parts, metal welding parts

[Contact Us](#)



Buy 45 Degree Bend Perforated Cable Tray at Best Price in Greater

A 45 Degree Bend Perforated Cable Tray is a specific type of cable tray configuration designed to facilitate changes in direction for routed cables. The 45-degree bend configuration is useful when

[Contact Us](#)



HOW TO BEND 90 DEGREE AND 45 DEGREE OF CABLE TRAY USING 3 BASIC FORMULA

PVC Trunking 12*7mm Adhesive Ultra-Small Wire Channel Surface-mounted Wire Duct Square Flame Retardant Cable Trunking Floor Cable Tray GXHL

[Contact Us](#)





Cable Tray Bend

FRP Cable Tray Bend is a piping or cable management component made from Fiberglass Reinforced Plastic (FRP), designed to provide a smooth, durable turn

[Contact Us](#)



Cable Tray Manufacturer and Accessories in Pakistan

Ladder Cable Tray Manufacturers and Supplier in Pakistan Al Fazal Engineering

[Contact Us](#)

Cable Tray Flat Bends , Cable Management , Metsec

Cable Tray Flat Bends Metsec Cable Tray Flat Bend Dimensions: 45° & 90° flat bends are available for light, medium and heavy duty cable tray systems with

[Contact Us](#)



45° Turn Bend Transition Tray

45° Turn Bend Transition Tray This model is a horizontal 45 degree turn bend transition tray. This 45 degree tray offers a 24" bend radius for ease of coax installation. Connects to any ASP cable tray

[Contact Us](#)





How to make cable tray bend / Cable tray offset formula / cable tray 45

How to make cable tray bend / Cable tray offset formula / cable tray 45 degree bend Queries Solved in This Video: cable tray 45 degree bend cable tray me offset

[Contact Us](#)

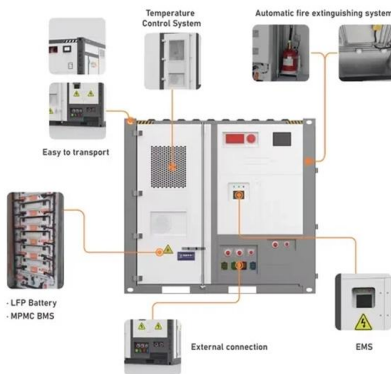
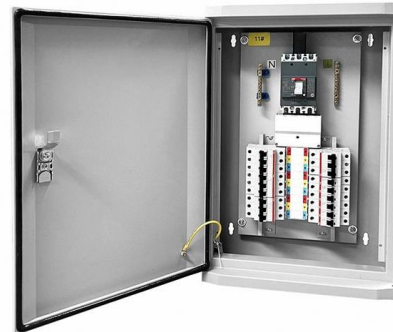

voestalpine Metsec

Providing products and expertise for the construction and manufacturing industries.

[Contact Us](#)

Cable Tray Bridge Bend Elbow Measurement & Fabrication

? Emma Johnson 80 15h · ? ? Cable Tray Bridge Bend Elbow Measurement & Fabrication Cable Tray Bridge Bend Elbow Measurement & Fabrication 192 ? 192 ? 1 ? 7 Pascal Duvet In chapeau de

[Contact Us](#)

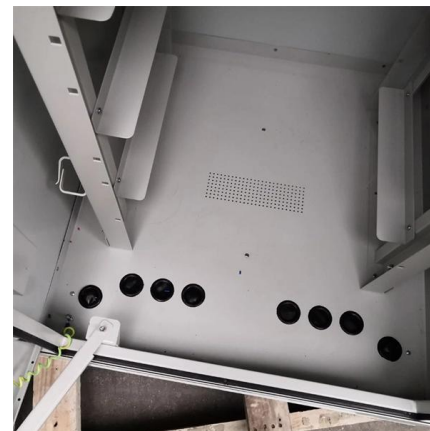

Bend Cable Tray

Manufacturer of Bend Cable Tray - 600mm Horizontal Bend Cable Tray, 100mm Bend Cable Tray, 45 Degree Bend Cable Tray and 90 Degree SS Bend Cable

[Contact Us](#)

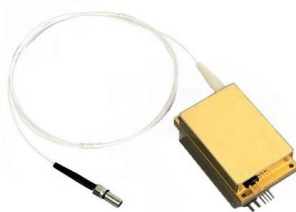



Cable Tray Bends

Heavy Duty 90 Degree External Bend 75mm £ 21.89 ex. VAT - £ 26.27 inc. VAT Heavy Duty 90 Degree Flat Bend 100mm £ 27.76 ex. VAT - £ 33.31 inc. VAT

[Contact Us](#)

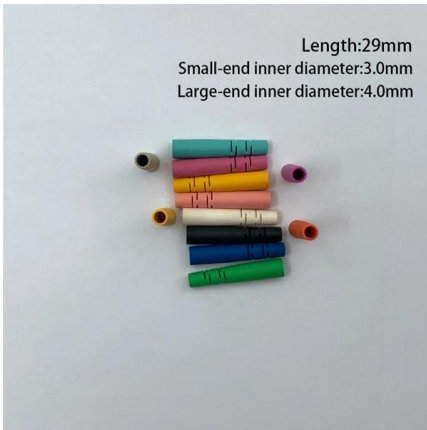

How to make a bend on an open cable tray

This video shows you how easy it is to form and bend an open cable tray from SILTEC - suitable for cables and pipes. See how easy it is to cut the threads away and bend the tray.

[Contact Us](#)

Cable Management Market Size & Share Outlook to 2031

Key Report Takeaways By product, cable trays captured 35.12% revenue share in 2025, while cable connectors and glands led growth with a

[Contact Us](#)

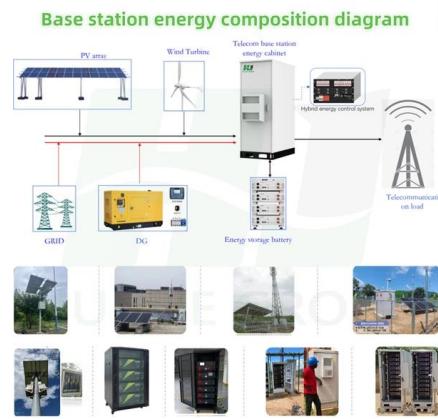

Cable tray

Common cable trays are made of galvanized steel, stainless steel, aluminum, or glass-fiber reinforced plastic. The material for a given application is chosen based

[Contact Us](#)



**Cable Support Systems Manufacturer
Malaysia , SAN Engineering**

SAN ENGINEERING AND ELECTRICAL SUPPORT - A
One Stop Center for all Types of Metal
Fabrication, Cable Support Systems and
Electrical Cable Infrastructure. Specialized in
Cable Tray,

[Contact Us](#)



Contact Us

For datasheets, pricing, or custom fiber access solutions, please visit:
<https://frindel.es>