

Austrian Modular Data Center 19-inch

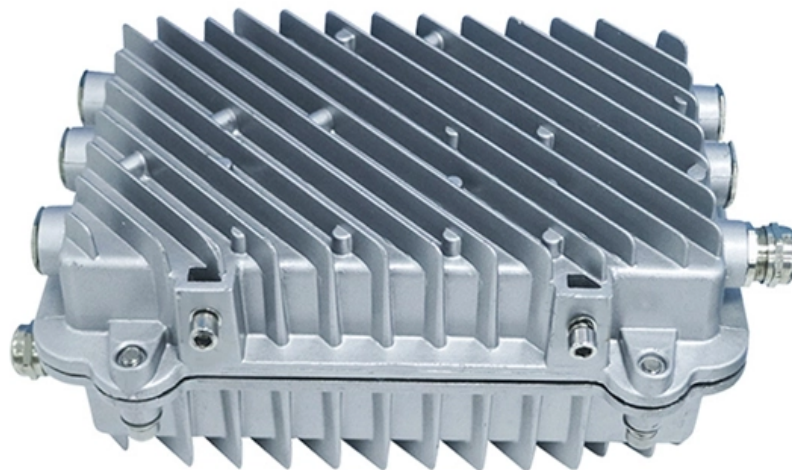

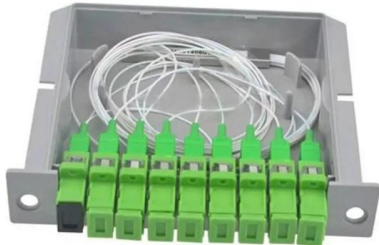

Austrian Modular Data Center 19-inch



Austria Data Centers

Data Centers in Austria with map. List of available providers and facilities in Austria, including Colocation, Bare Metal Servers, and IaaS Data Centers.

[Contact Us](#)

Micro Data Center in 19" Server Rack

For small, medium-sized or large companies - with the mini data center, your IT is immediately ready for use and can be expanded modularly at any time. You decide whether to rent or buy.

[Contact Us](#)

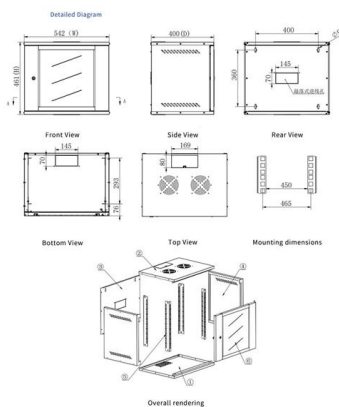
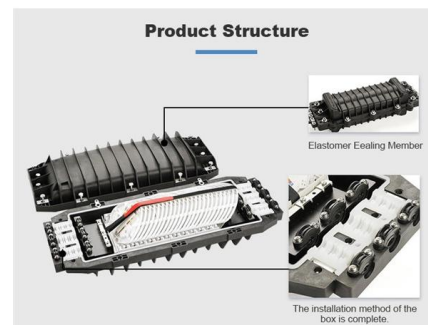

Fleischmarkt Vienna

With its own data center in the heart of Vienna at Fleischmarkt 19, next layer offers its customers a new data center with optimal accessibility and the highest

[Contact Us](#)

Unlocking Efficiency and Agility: The Guide to Modular

Find out how modular data centers can ensure scalability for future expansions, embody repeatable designs, and exhibit superior quality via factory



The Modular Data Center Ultimate Guide

A modular data center is a quick, flexible, and cost-effective way to boost your data storage. Using prefabricated modules, these centers are

[Contact Us](#)

Austria Data Centers

List of available providers and facilities in Austria, including Colocation, Bare Metal Servers, and IaaS Data Centers.

[Contact Us](#)

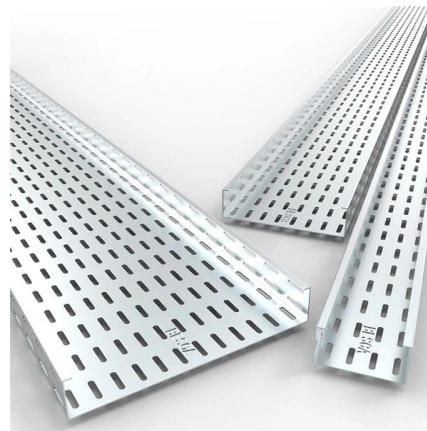

Prefabricated Modular Data Center , Huawei Digital Power

Modular Data Center Market Size & Growth Drivers

Modular Data Center Market Size & Share Analysis - Growth Trends and Forecast (2026 - 2031) The Modular Data Center Market Report is

[Contact Us](#)



Huawei delivers prefabricated modular data center solutions with One Module One DC and container data center designs, enabling fast deployment and scalable

[Contact Us](#)



Austria Data Centers

We currently have 52 data centers listed, from 12 markets in Austria (Österreich). Click on a market below, to explore its data center locations. Save the trouble of

[Contact Us](#)



Europe Prefabricated and Modular Data Centers Market

The Europe prefabricated and modular data centers market was valued at \$1,004.7 million in 2024 and is expected to grow at a CAGR of 15.05% and reach \$4,081.5 million by 2034

[Contact Us](#)



Europe Prefabricated and Modular Data Centers Market: Focus on Data

Consequently, the prefabricated and modular data centers market represents a high-growth and high-revenue business model with substantial opportunities for industry players.

[Contact Us](#)





Mobile Rack for Servers: Modular 19-Inch Flight Cases

Discover the mobile rack for servers--modular, shock-protected, and ideal for edge computing. Find your perfect portable solution now!

[Contact Us](#)



19" modular rack enclosure and server racks

CUBIC high-quality 19" or modular PDU enclosure solutions for personal safety and operational dependability.

[Contact Us](#)

52 companies for Modular Data Center Construction in Austria

Discover all relevant Modular Data Center Construction Companies in Austria, including CONTAINEX Container-Handelsgesellschaft m.b.H. and Base-IT

[Contact Us](#)



Wien Data Centers

Data Centers in Wien with map. List of available providers and facilities in Wien, Austria, including Colocation, Bare Metal Servers, and IaaS Data Centers.

[Contact Us](#)



Modular Data Centers: Prefabricated



Containers and

Modular data centers are pre-engineered, prefabricated, and standardized buildings, equipped with power and cooling, that house servers and

[Contact Us](#)

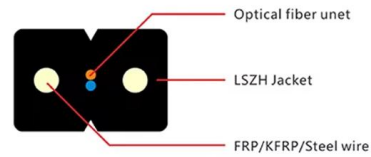

19" Cabinets , Server Racks , 19" Enclosures , Wall Boxes

They design racks to fit equipment that is 19 or 23 inches wide. This uniformity allows users to mix and match equipment from different vendors, knowing the rack structure will physically fit the equipment.

[Contact Us](#)

Prefabricated Modular Data Center

Prefabricated modular data centers, also known as integrated modular solutions or containerized data centers, are engineered to meet business-specific requirements to fit in a right-sized secure

[Contact Us](#)



Prefabricated modular solutions

However, in contrast, modern modular data centers are conceived, produced, and tested off-site concurrently with site preparation, yielding over 40% time savings

[Contact Us](#)



19" Rack PCs , InoNet

Long-term available 19-inch PCs are a fundamental building block for innovation and progress in the industry. With its rack PCs, InoNet delivers the result of well

[Contact Us](#)

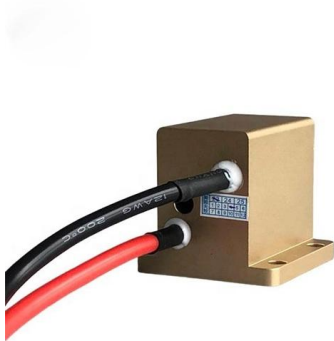

Modular Data Centers: When They Work, and When

Modular data centers offer fresh opportunities for the industry, but that doesn't mean they are right for every occasion.

[Contact Us](#)

Order 19-inch data racks online

Explore our extensive selection of 19-inch network and server racks, available in a variety of designs and functionalities. Our professional range includes around

[Contact Us](#)



Vienna Data Centers

Vienna Data Centers Below you will find locations of 27 data centers in Vienna (Wien), Austria. To find other data center locations and colocation, cloud or

[Contact Us](#)

Techrack , Build Your Own Server Rack , 19



inch Rack Mounts

This modular approach to server rack cabinets allows you to create the perfect cabinet required for your growing data center. Select the the specific FRAME and then add the components you

[Contact Us](#)



Facilities and Data Centers in Austria , DataCenterJournal

The Data Center Journal has collected the details of all 38 facilities found in Austria. Use our statistics and organization details to shape your final decision.

[Contact Us](#)

Modular Data Center Market Size, Growth and Forecast

Modular Data Center Market size was valued at USD 30.26 billion in 2024 and is anticipated to reach USD 110.69 billion by 2032, at a CAGR of 17.6% during the

[Contact Us](#)

DETAILS DISPLAY

Focus On Every Detail



01

Neat & Clean Layout

Cleaner arrangement of components. Easy to operate

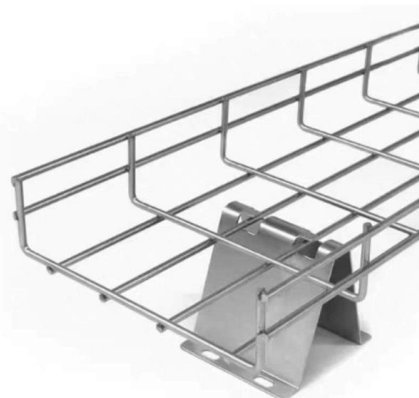

Omdia projects Open Rack enclosures to become the

As the transition from 19-inch EIA-310 Rack Enclosures to 21-inch Open Rack Enclosures takes hold of the data center rack market, we expect

[Contact Us](#)



Custom Modular Data Centers for Edge & AI , ModulEdge

Factory-built modular data centers for AI, edge computing, and critical infrastructure. Deployed in 3-6 months. Operates from -35C to +52C. European engineering.

[Contact Us](#)



Contact Us

For datasheets, pricing, or custom fiber access solutions, please visit:
<https://frindel.es>