

# **48-core optical cable Telefónica Spain**

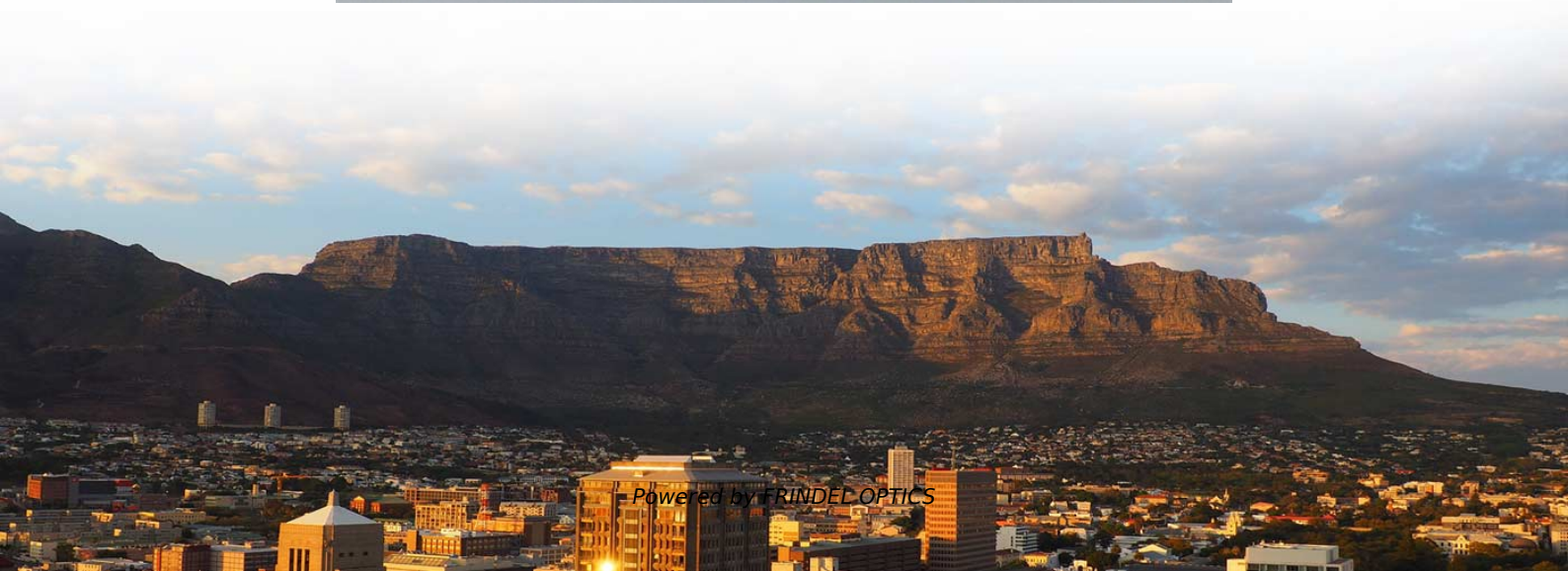



## 48-core optical cable Telefónica Spain

---



### Telefónica will achieve 100% fibre coverage in Spain by

Telefónica will make the greatest effort to promote the complete digitalisation of Spain: it is committed to ensuring that by 2025 fibre optics will

[Contact Us](#)

### Cable OPGW de 48 cores-Dosense Cable Manufacturer

OPGW optical cable (optical ground cable) of 48 cores has 48 optical fibers integrated into the OPGW structure. This type of cable is used in power transmission networks and combines shock resistance



[Contact Us](#)

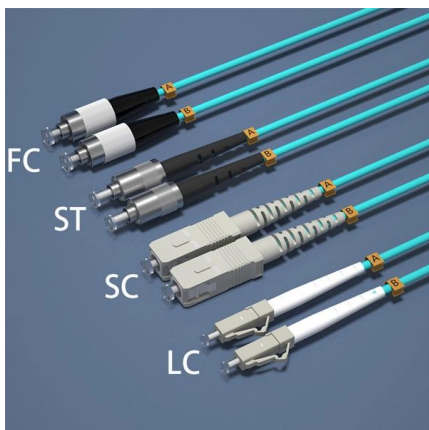

### The success story of Spain's fibre optic networks

Spain is one of the EU's leading countries when it comes to excellent network connectivity, and it's all thanks to public and private investment in fibre optic.

[Contact Us](#)

### 48 Core/24Cores OPGW Fiber Optic Cable

48 Core G652D Opgw Fiber Optic Cable  
Description: OPGW fiber cable is the short form of Optical Fiber Composite Overhead Ground Wire. OPGW cable is

[Contact Us](#)

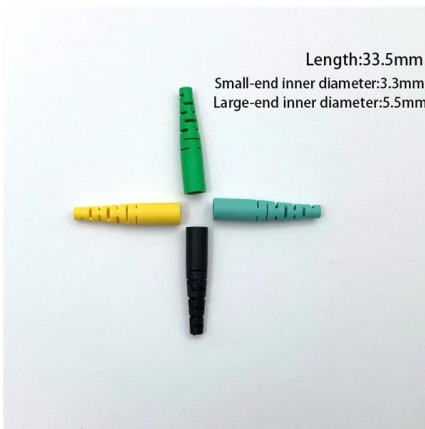
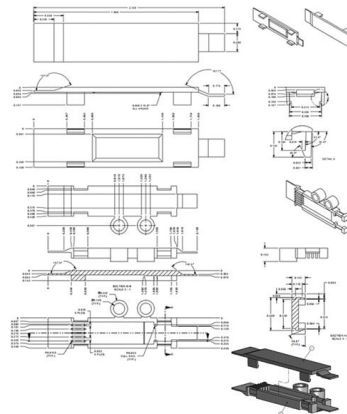

### OPGW 48 Core Optical Fiber Cable

Zion Communication is a leading China manufacturer of OPGW 48 Core Optical Fiber Cable, providing high-quality Optical Ground Wire solutions with robust mechanical strength and excellent fiber

[Contact Us](#)

### Telefónica and Vodafone to sell 40% of fiber subsidiary

Telefónica and Vodafone are accelerating their plans to bring in a minority partner to their newly created subsidiary that groups their optical fiber.

[Contact Us](#)

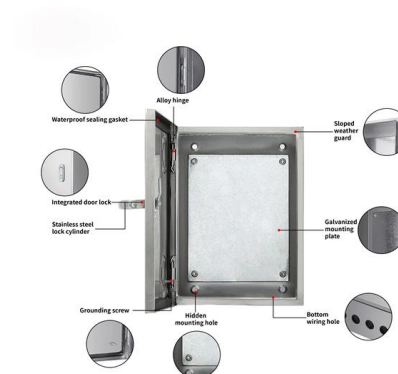

### Telefónica, Vodafone, and Orange agree to share in-building fiber in

Three operators in the Spanish market - Telefónica, Vodafone, and Orange - have signed an agreement that allows infrastructure sharing of fiber-optic cable in the vertical section of

[Contact Us](#)



### How Many Core In Fiber Optic Cable Do I



For example, if you have three optical fiber access switches, you need to have three cores. (actually use a four core optical cable) This is because apart

[Contact Us](#)



### **Telefónica España and Vodafone España have signed a**

Vodafone España is a national provider of fixed, mobile and TV services in Spain, providing services to consumers, business and government customers. It was acquired by Zegona in May 2024.

[Contact Us](#)

### **Telxius: High-capacity Fibre Optics via Submarine Cable**

Telxius connects the world's main data centers via more than 82,000 km of high-capacity submarine fibre optic cable.

[Contact Us](#)



### **Bluevía now offers fibre coverage in more than 3,500**

This deployment means offering fibre in a total of 48 provinces,

[Contact Us](#)





### Alcatel-Lucent will develop Telefónica's 100G optical network in Spain

Alcatel-Lucent and Telefónica have agreed to deploy 100 Gbps (gigabits per second) optical networks in the northwest, east and south regions of Spain.

[Contact Us](#)



### Investment Portfolio: Fiber Optic, Data Centers and

Discover Telefónica Infra's portfolio of assets and investments in fiber optics, data centers and submarine cable.

[Contact Us](#)

### Say goodbye to copper cables in Europe

Ever since Telefónica - Spain's main provider of telephony services and connectivity - began decommissioning its copper exchanges back in 2016, the final phase of

[Contact Us](#)



#### An Extensive Library of Self-Developed Products



Optical Distribution Frame



Rack Mount Fiber Patch Panel



Stand Network Cabinet



Fiber Optic Distribution Box



Fiber Adapters



Copper Cable Patch Panel

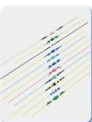

Fiber Patch Cords

### Fiberpass: Wholesale fibre optic

Fiberpass is a company that provides wholesale fibre optic and other connectivity services over fibre technology to Telefónica España and Vodafone Spain in

[Contact Us](#)



## 24 Core and 48 Core Fiber Optic Cable

24 Core and 48 Core Fiber Optic Cable Fiber optic cable is a cable containing one or multiple optical fibers that are used to transmit the signal. The optical fiber

[Contact Us](#)



## Telefónica's Bold Leap to Fiber Optics in Spain , TechAnnouncer

Telefónica, Spain's leading telecommunications provider, is making significant strides in its transition from copper to fiber optic networks. This shift aims to enhance connectivity across urban

[Contact Us](#)

## Vodafone Spain and Telefónica create FibreCo as fiber

The transaction, subject to regulatory approvals, will strengthen broadband supply in Spain. Once the transaction is closed, both companies

[Contact Us](#)

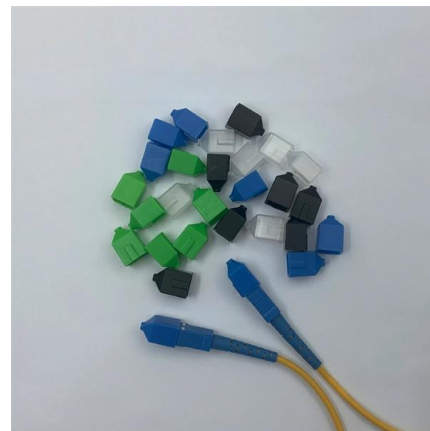

## Fiber optics in Spain: investments, deployments and cuts

According to market sources, AXA is considering entering with around 30% in the joint venture fiber of Telefónica and Vodafone Spain, in a

[Contact Us](#)



## How to Choose the Suitable Number of Fiber Cores for

Fiber optic cables are essential to modern networks, enabling high-speed and reliable data transmission. Among their many features, the number of

[Contact Us](#)



## Spain, The European Country With The Most Fibre Optics

Once again Telefónica, which with its fibre deployment has contributed greatly to making Spain the European country with the most fibre optics, is developing its activity in line with the needs

[Contact Us](#)

## Telefónica's Bold Leap to Fiber Optics in Spain

Conclusion Telefónica's transition to fiber optics marks a significant step forward in enhancing Spain's telecommunications infrastructure. By

[Contact Us](#)



## Vodafone Spain and Telefónica create FibreCo as fiber

FibreCo will cover 3.6 million premises, enabling Vodafone and Telefónica to maximize use of the FTTH network and provide high-quality fiber

[Contact Us](#)



## Copper network switch-off

In the midst of the 2008 financial crisis, Telefónica decided to deploy a new network that has left our country in a historic place by being the first

[Contact Us](#)



## Telefónica makes progress with its digitalisation plan

The telecom company has taken a step forward by replacing these copper exchanges with fibre optic lines, helping to position Spain as the European

[Contact Us](#)

## Vodafone Spain & Telefonica sign FibreCo contract

This new FibreCo will cover 3.6 million premises across Spain, providing fibre access services for 1.4 million Vodafone Spain and Telefonica customers. FibreCo will provide access to the

[Contact Us](#)



## Telefónica España desplegará un nuevo cable

Telefónica España acometerá el despliegue del cable submarino PENCAN-X para unir Canarias con la Península Ibérica.

[Contact Us](#)



## Telefónica's Digital Deal promises fiber throughout Spain by 2025

Among other things, the plan calls for Telefónica to cover all of Spain with its fiber-optic network by 2025.

[Contact Us](#)



## Sumitomo optical fiber 48 core

Sumitomo 48-core fiber optic cable is a completely standard cable that is suitable for terrestrial environments. This fiber optic cable has a single mode function and its wires are waterproof and

[Contact Us](#)

## Telefónica to build subsea cable connecting Canary Islands and Spain

Spanish operator Telefónica is planning to deploy a subsea cable connecting the Canary Islands to the Iberian Peninsula in mainland Spain. Dubbed the Pencan-X project, the cable will offer

[Contact Us](#)

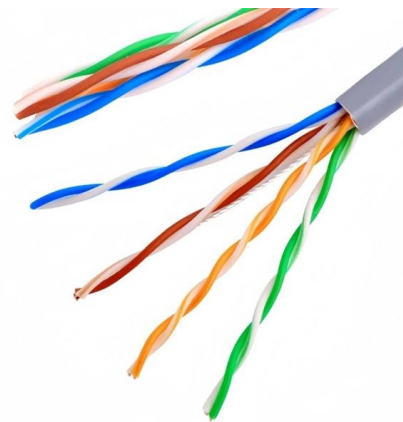

## Contact Us

---

For datasheets, pricing, or custom fiber access solutions, please visit:  
<https://frindel.es>